

BOCCI

Product Overview 2022



Based between Vancouver and Berlin, Omer Arbel cultivates a fluid position between the fields of architecture, sculpture, invention and design.

Focal themes of his work include ongoing investigations of intrinsic mechanical, physical and chemical qualities of materials, and the exploration of light as a dynamic medium.



Vancouver studio (top)
Future Berlin studio (bottom)



Product

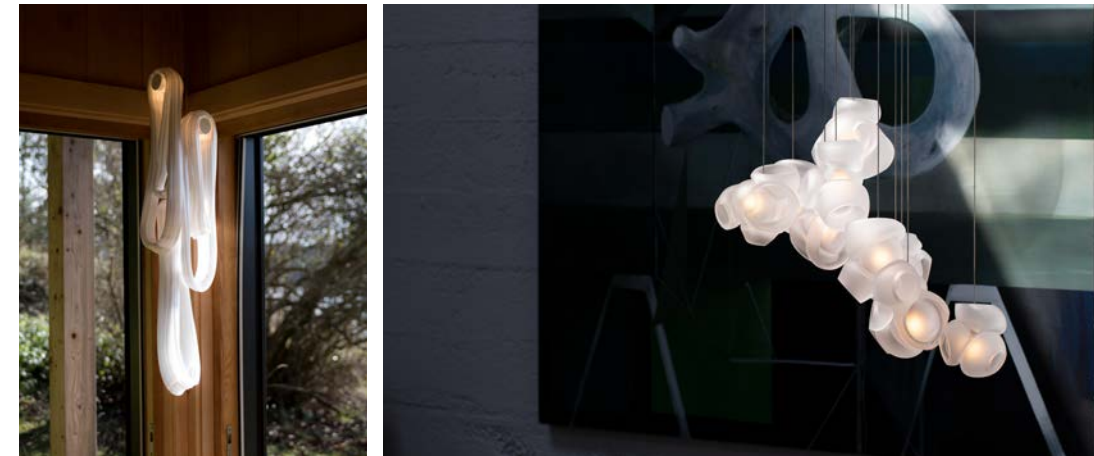

14

14 is an articulated, cast glass sphere with a frosted cylindrical void that houses either a low-voltage xenon or LED lamp. Individual pendants are visually subtle, but gain an atmospheric quality when multiplied and clustered in groups.



Lamping

1.5w LED or 10w xenon

Material

cast glass, blown borosilicate glass, braided metal coaxial cable, electrical components, brushed nickel or white powder coated canopy



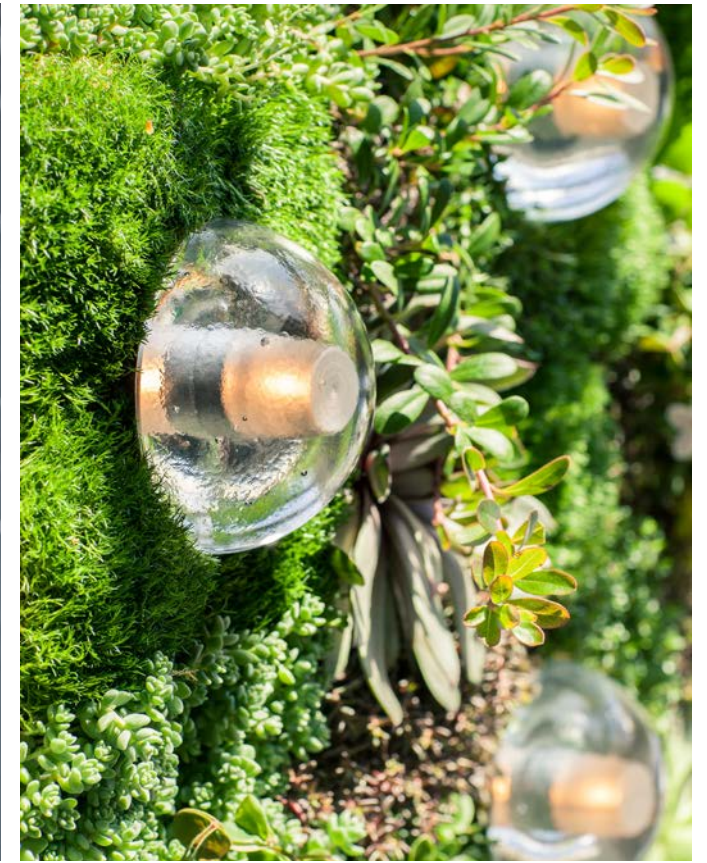

16

16 is formed by sequentially pouring three separate layers of molten glass – in varying opacities – on a horizontal plane. Each layer responds to the indeterminate shape of the previous pour to create a uniquely layered whole. Two of these pieces are then attached and illuminated with an internal LED lamp. The 16 series is available in 4 colours.



Lamping

1.5w LED

Material

poured glass, electrical components, bead blasted stainless steel armature components





grey 1

grey 2

white 1

white 2

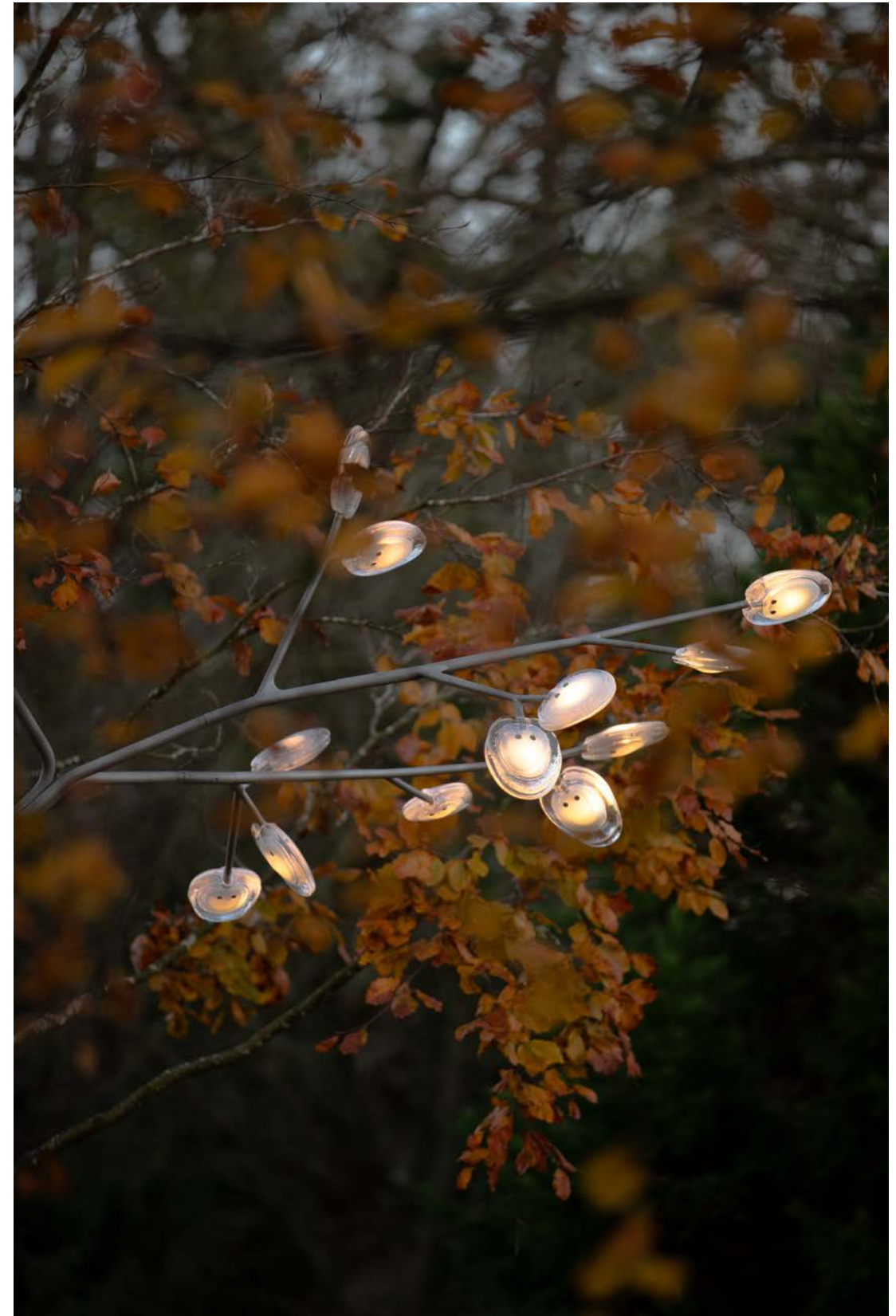

21 results from a fabrication process in which thin porcelain sheets are draped over an inverted diffuser made of sandblasted borosilicate glass. The thin porcelain skin is allowed to dress the borosilicate core in whatever form occurs naturally – creating a unique shape in every iteration of the fabrication process.



Lamping

1.5w LED or 20w xenon

Material

porcelain, blown borosilicate glass, braided metal coaxial cable, electrical components, brushed nickel or white powder coated canopy



28 results from an innovative fabrication process that manipulates both the temperature and the direction of air flow into blown glass. The result is a slightly distorted sphere with an interior landscape of satellite shapes, including an opaque milk glass diffuser that houses either a low-voltage xenon or LED lamp.



Lamping

1.5w LED or 20w xenon

Material

blown glass, braided metal coaxial cable, electrical components, and brushed nickel or white powder coated canopy







38_38V

38 pushes the fabrication technique originally developed for 28 to its technical and material limits. A large glass sphere is blown with a multitude of haphazard interior cavities, which intersect and collide with each other in unpredictable ways.



Lamping

1.5w LED or 10w xenon

Material

cast glass, blown borosilicate glass, braided metal coaxial cable, electrical components, brushed nickel or white powder coated canopy



38 copper



38 copper



38V random



44

Each 44 results from a free pour of molten aluminium into a large canister filled with rock-like modules of resin-impregnated sand, a waste product of conventional sand casting. Low voltage electricity is transmitted through the castings, allowing a light source to be suspended between them without using cables.



Lamping

1.5w LED

Material

cast aluminum, braided metal coaxial cable, aircraft cable, electrical components, white powder coated canopy



57

57 results from a fabrication process whereby air voids of different sizes and configurations are composed within a larger mass of dark grey or white opaline glass. These air pockets are invisible when the piece is unlit, and come alive to reveal an interior universe when 57 is illuminated. By virtue of the method of making, each 57 is completely unique.



Lamping

1.5w LED

Material

blown and dipped glass, cast borosilicate glass cap, powder coated steel and brass hardware, swag hooks, braided metal coaxial cable, aircraft cable, electrical components, and white powder coated canopy.





white opaline

light mirror



grey

dark grey

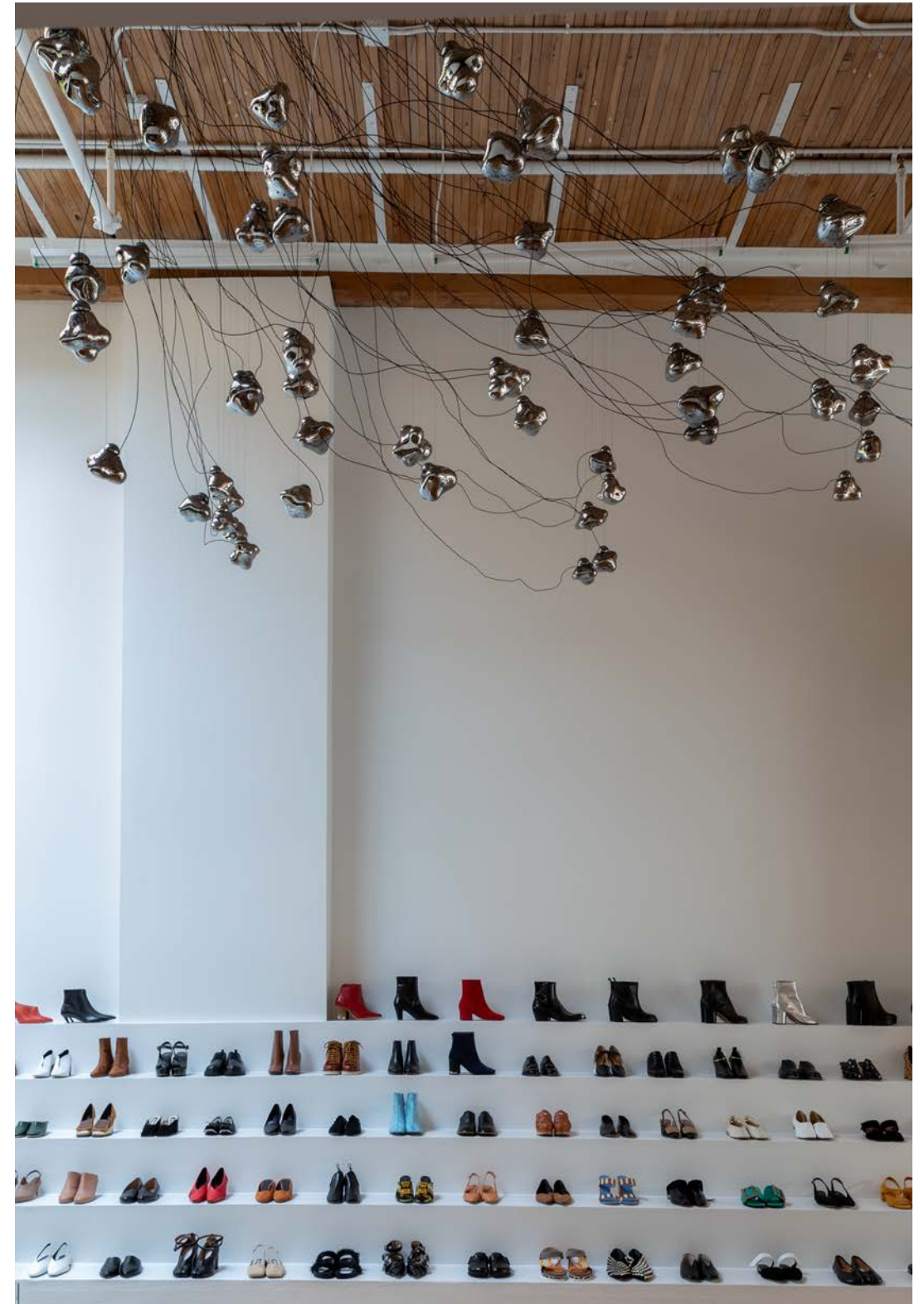

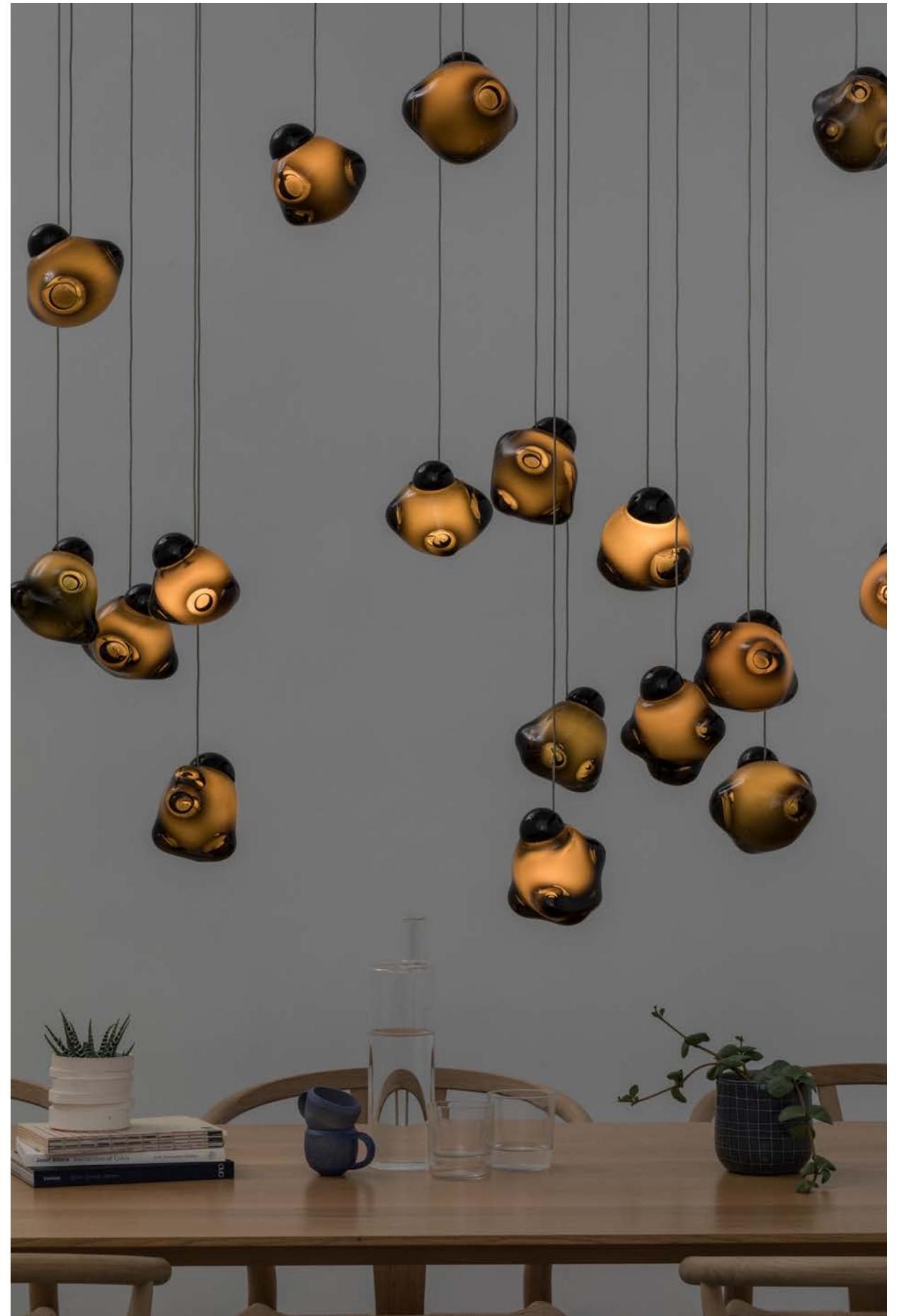

73 results from blowing liquid glass into a folded and highly heat-resistant ceramic fabric vessel. The resulting shape has a formal and textural expression intuitively associated with fabric, which becomes permanent and rigid as it cools. A xenon or LED is positioned to fill the resulting volume with diffuse light, accentuating the volumetric perception of the piece.



Lamping

1.5w LED or 10w xenon

Material

blown glass, braided metal coaxial cable, electrical components, brushed nickel or white powder coated canopy









73V

73V is an expansion of the technique used to create Bocci's popular 73 series. The new pendant features a novel oblong shape and gradient colour range. 73V results from blowing molten glass into a folded, heat-resistant ceramic fabric. The resulting shape has a formal and textural expression intuitively associated with fabric, which becomes permanent as it cools. A light source is positioned at the top of each pendant, accentuating the volumetric perception of the piece as well as the gradation of colour.



Lamping

1.5w LED or 10w xenon

Material

blown glass, braided metal coaxial cable, electrical components, and brushed nickel or white powder coated canopy.





clear

grey 1

purple 1



blue 1

opaque white 1

opaque green 1



opaque blue 1





74

74 is a new LED spotlighting system designed as an alternative to conventional track lighting. The spotlights are housed inside articulated mirrored spheres that are affixed with a magnet, allowing maximum control over the emitted cone of light. Low voltage electricity passes through delicate coaxial cables freely composed in three-dimensional space, with the adjustable spheres located at certain intersections.



Lamping

5w MR16 LED

Material

plated steel, cast borosilicate glass, braided one-directional cable, electrical components, white power coated steel canopy

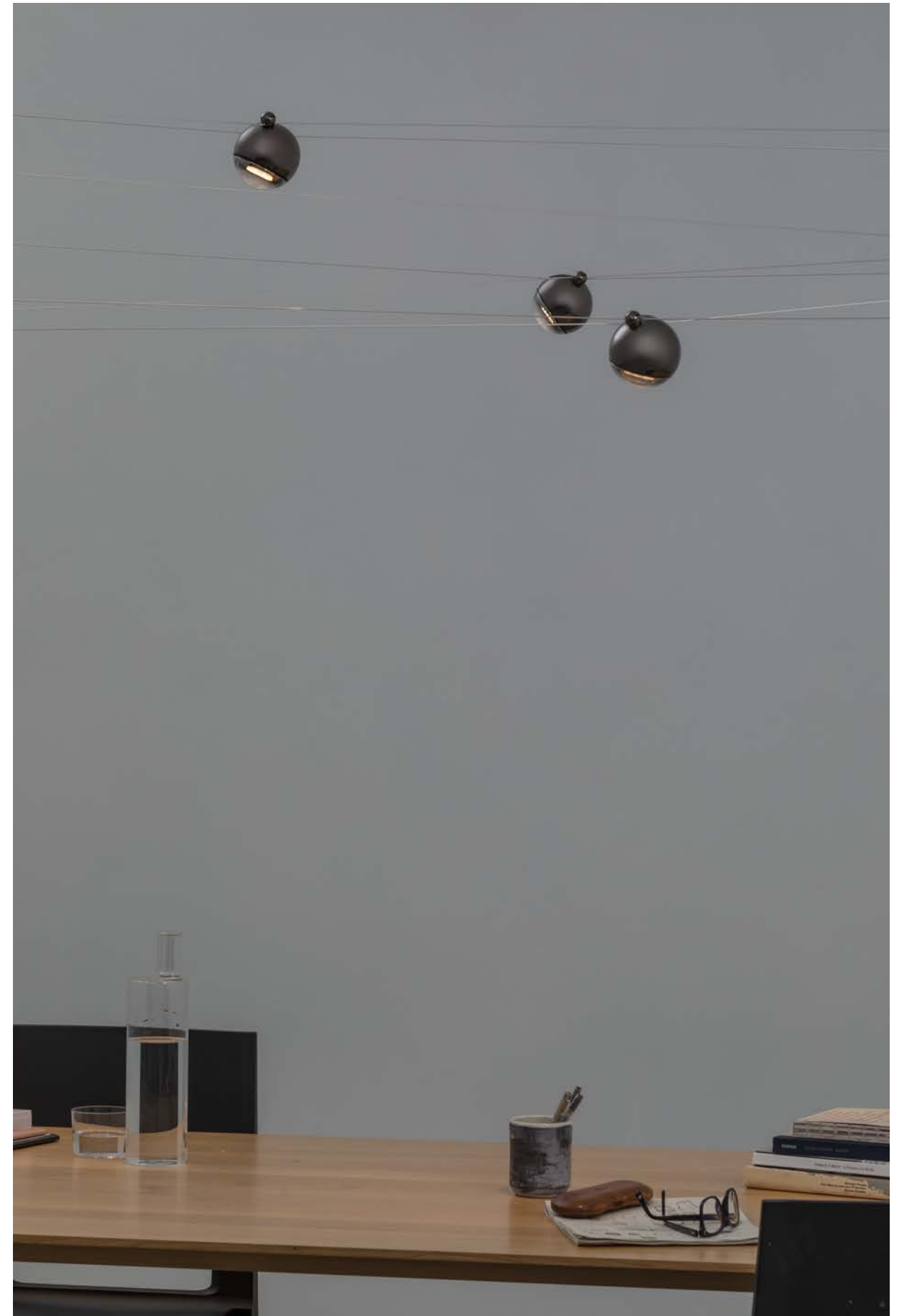

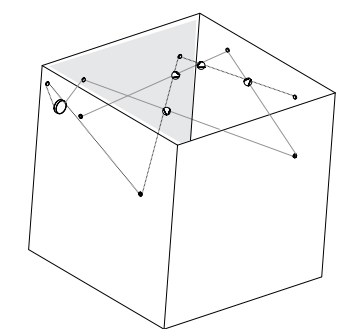
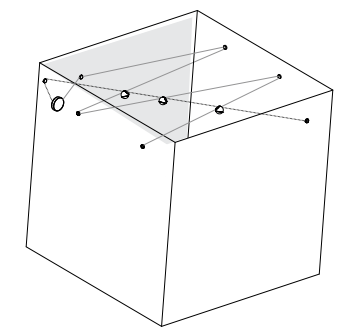
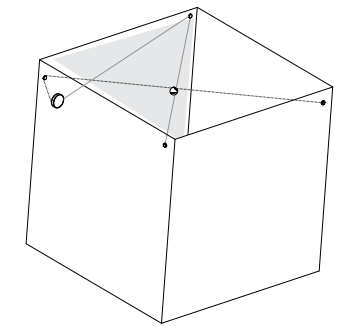

A vacuum is introduced to a strata composed of hot white and clear glass with copper mesh between; the vacuum causes the white layer to pull away through the embedded mesh, leaving numerous tendrils of white glass suspended within an interstitial space as it goes.



Lamping

1w LED

Material

blown glass, copper mesh, braided metal coaxial cable, electrical components, and brushed nickel or white powder coated canopy.





84

A white glass moll is captured inside a fine copper mesh basket and then plunged into hot clear glass. Air is blown into the matrix to gently push the white glass through the mesh, creating a delicate pillowed form that is suspended inside the thick outer layer of clear glass. Sometimes the copper mesh basket folds and crinkles, adding specificity to each piece. Undulations in the exterior shape are a natural consequence of the fabrication process and accentuate the gentle white pillowing below. A low-voltage xenon or LED light source is introduced into the piece, casting a warm coppery hue.



Lamping

1.5w LED or 10w xenon

Material

blown glass, copper mesh, braided metal coaxial cable, electrical components, and white canopy





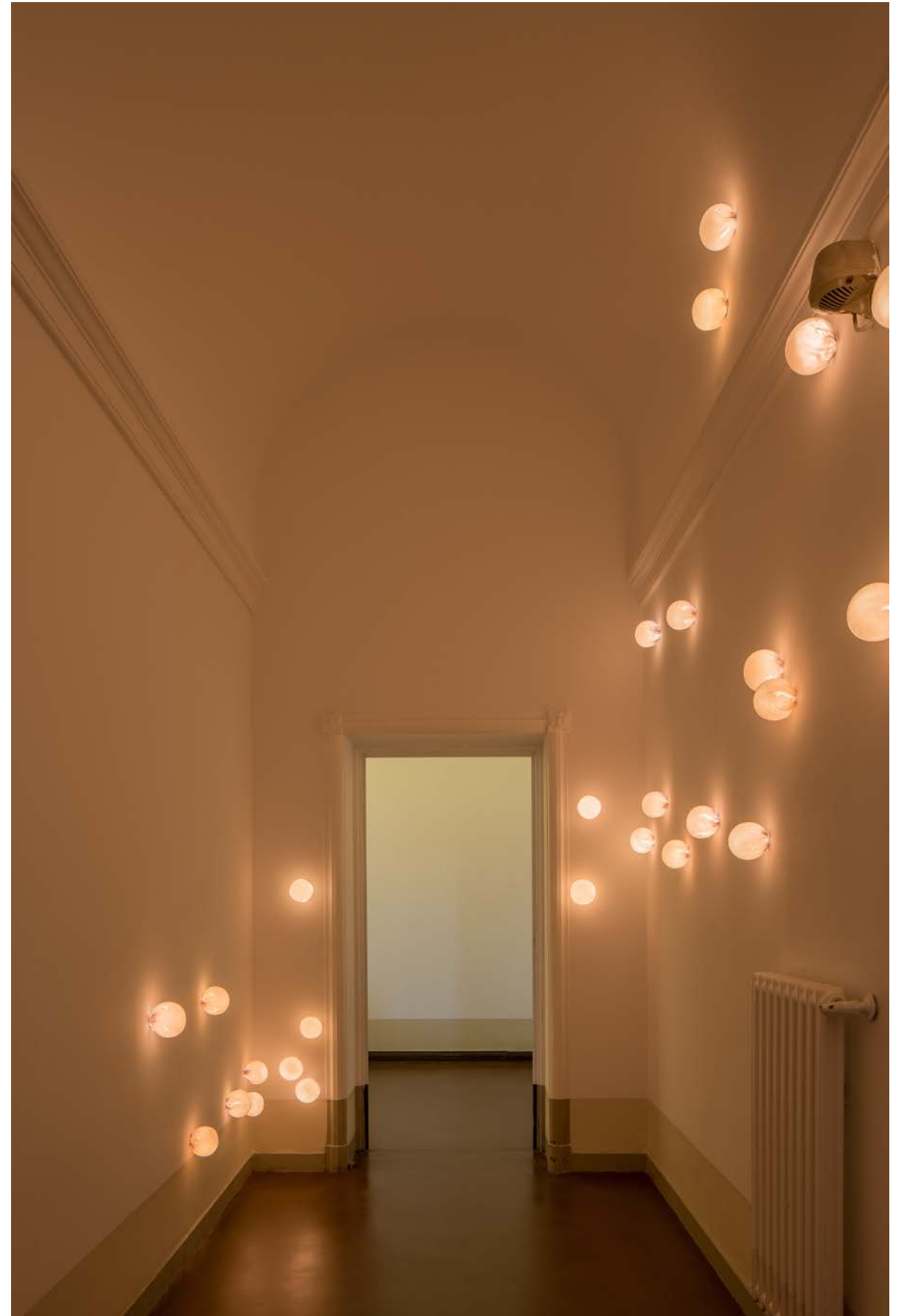

Soda water is used to trap air in a super heated glass matrix, which is vertically stretched and folded back onto itself between pegs numerous times. As the glass cools, the folding motion along the grain of the loop turns the entrapped air into microfilaments that give the piece a pearlescent optical quality. A low-voltage xenon or LED light source is introduced at one end of the loop casting light through the microfilaments and registering a gentle gradient.



Lamping

1.5w LED or 10w xenon

Material

pulled glass, braided metal coaxial cable, electrical components, and brushed nickel or white powder coated canopy



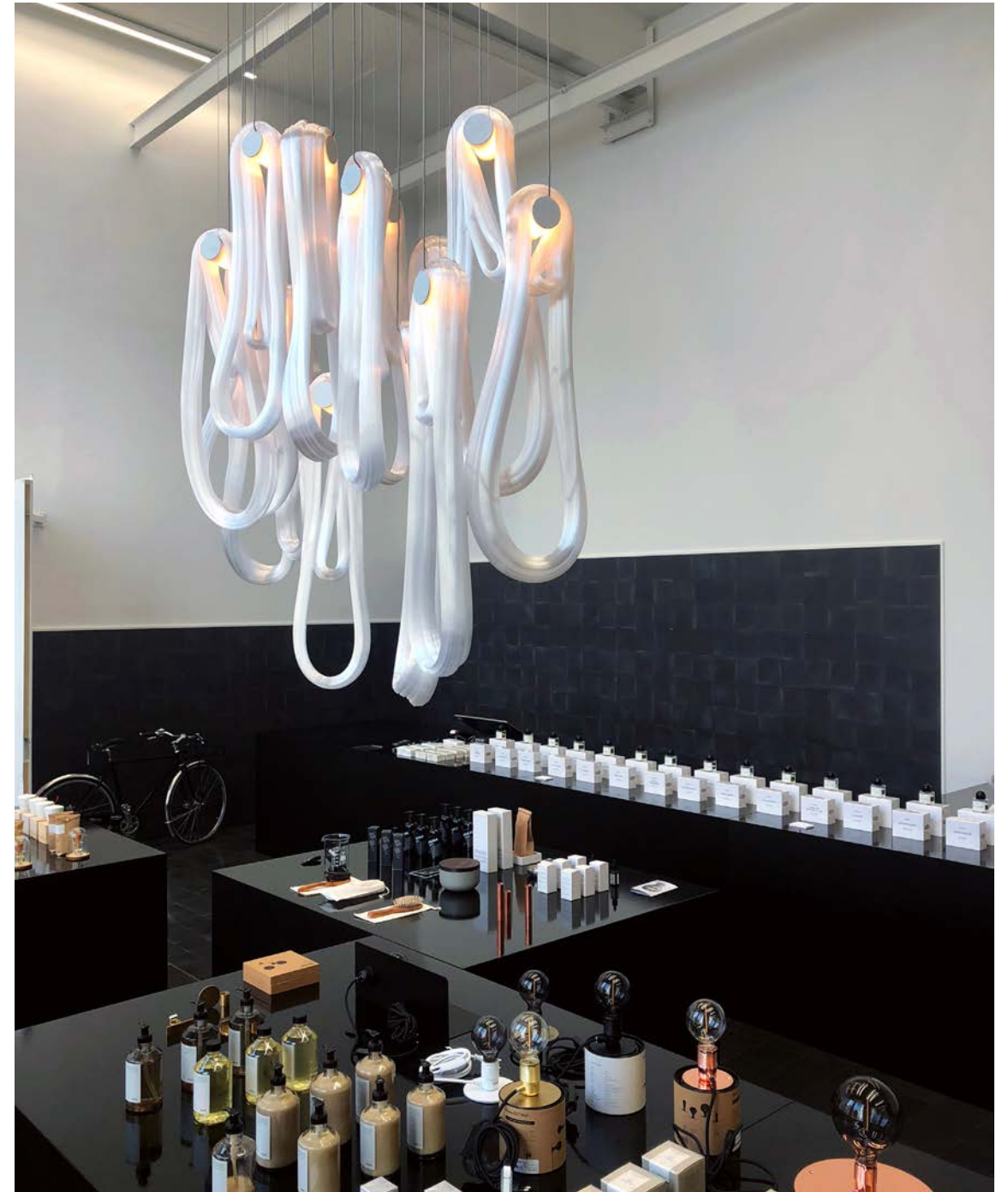

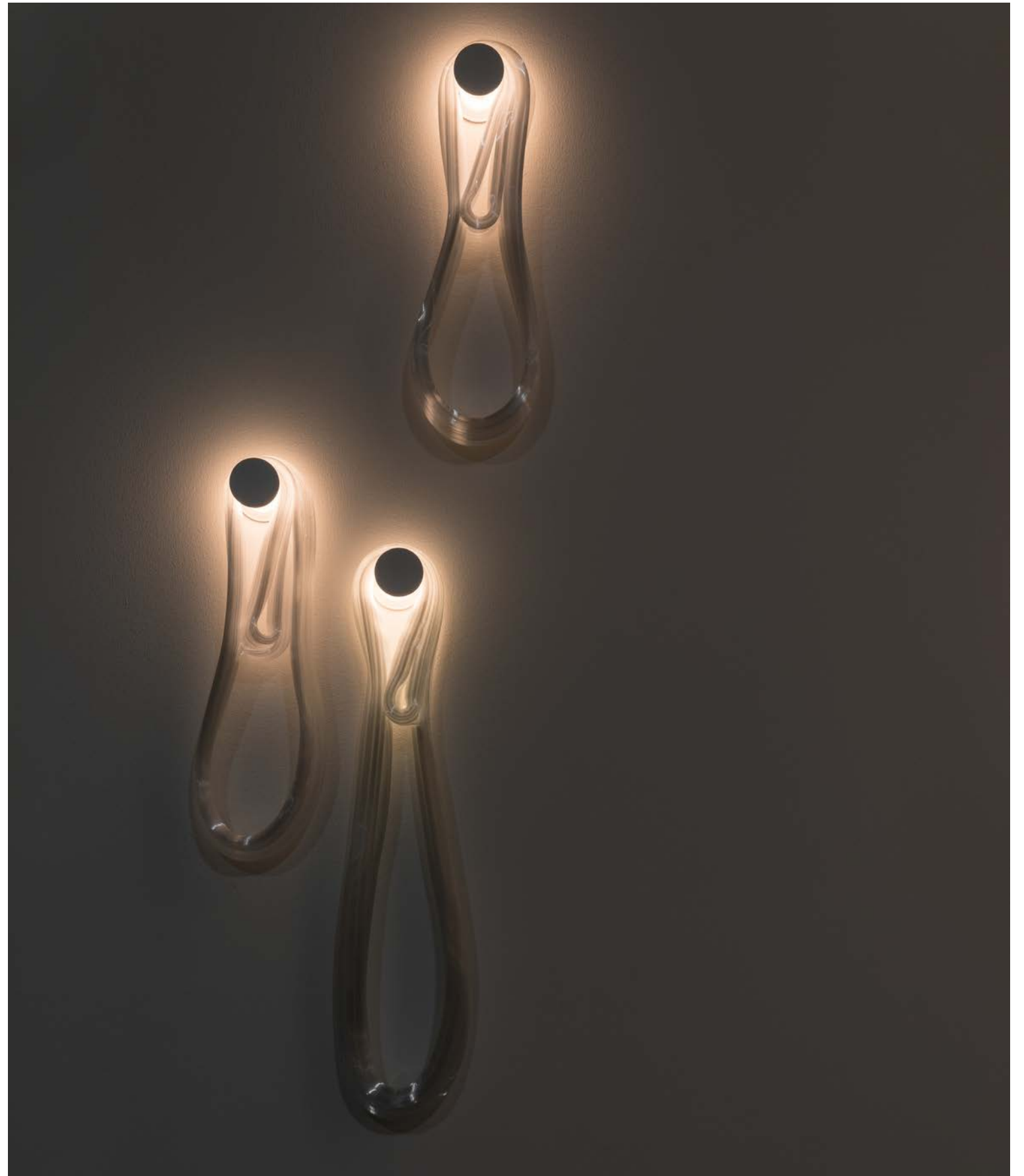
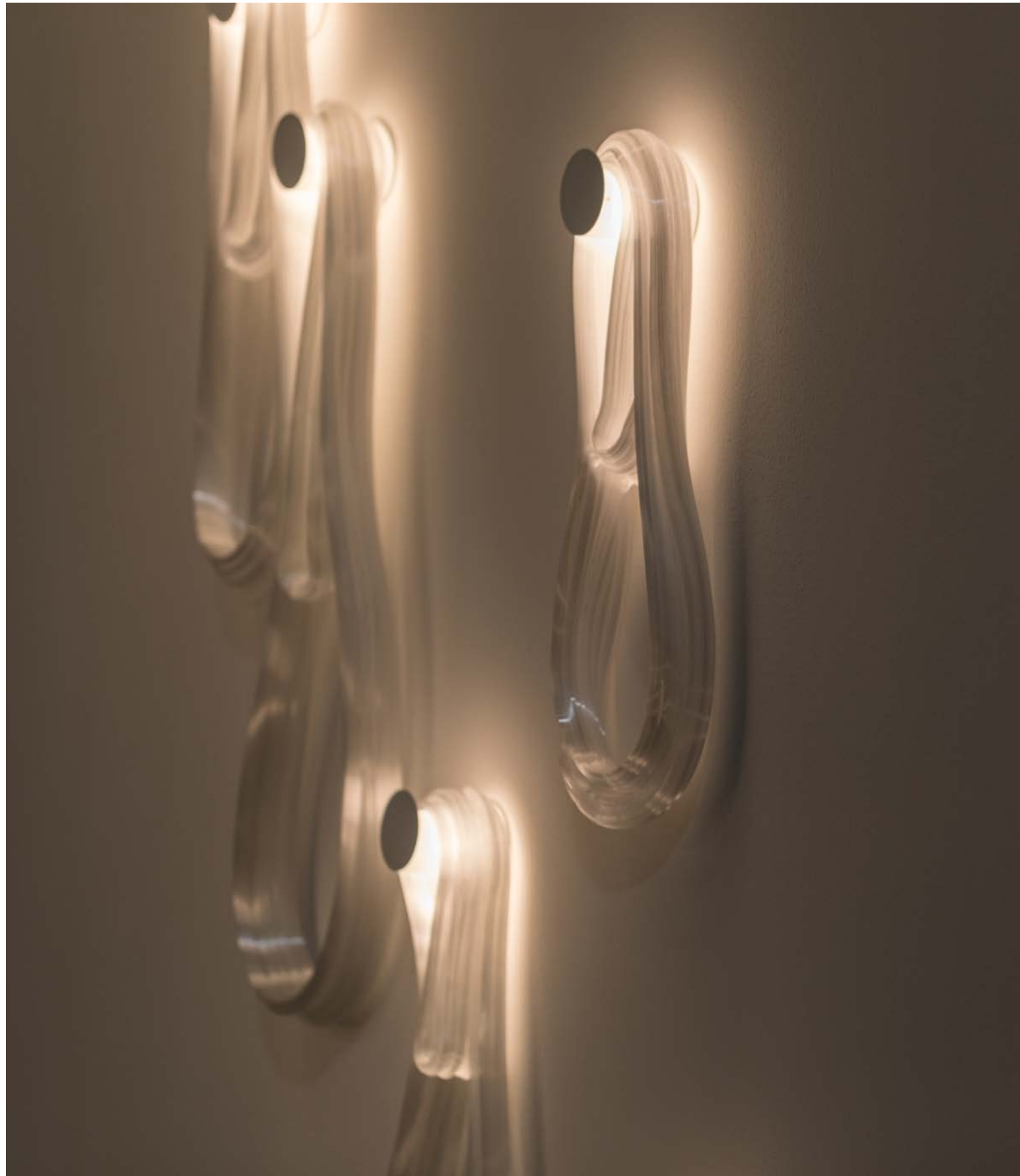

100

100 brings multiple glass artists together in a performative act. Molten glass bubbles are prepared by each, then smashed together to produce unpredictable interlocking glass forms.



Lamping

1.5w LED

Material

blown glass, braided metal coaxial cable, electrical components, and white canopy

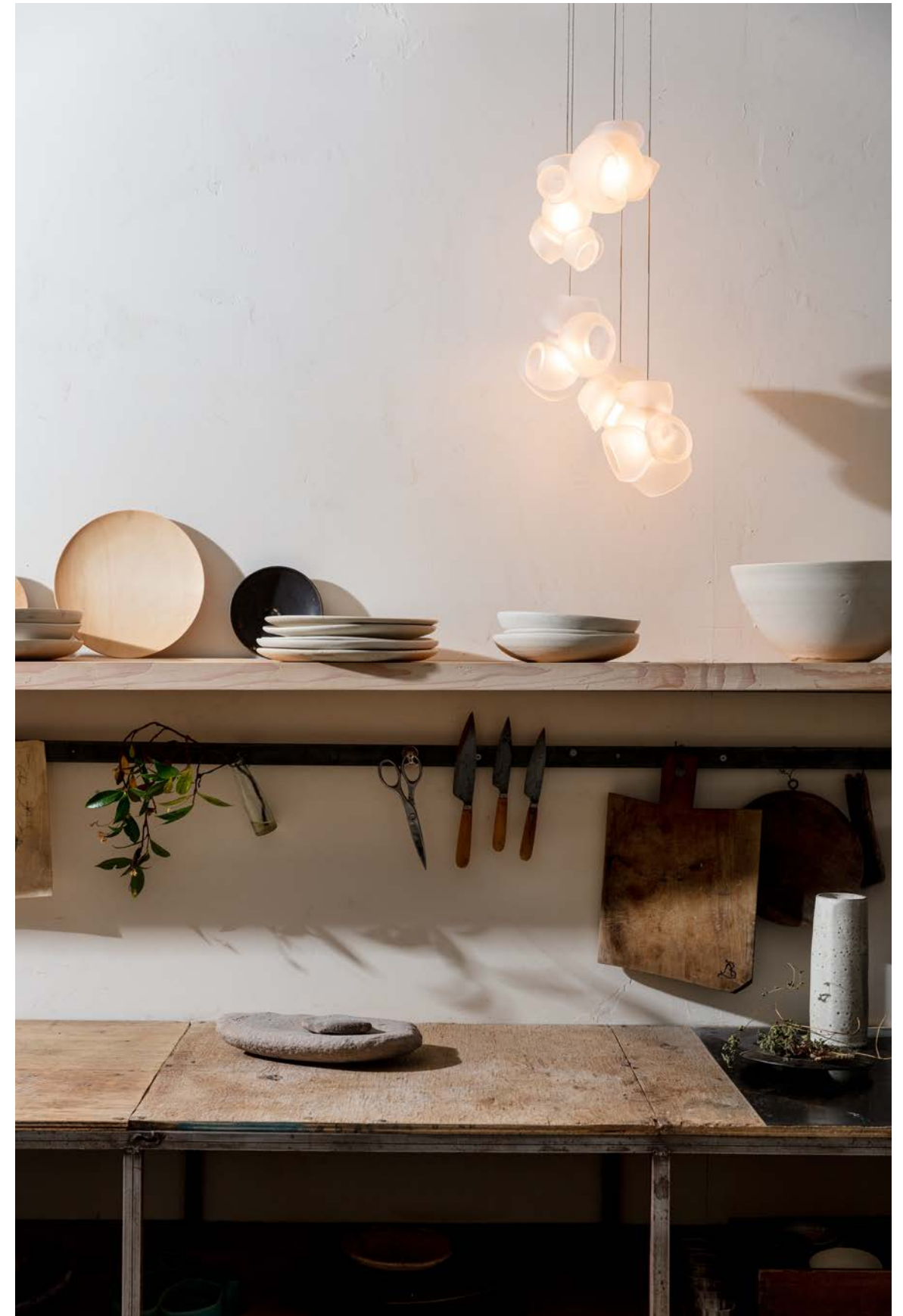



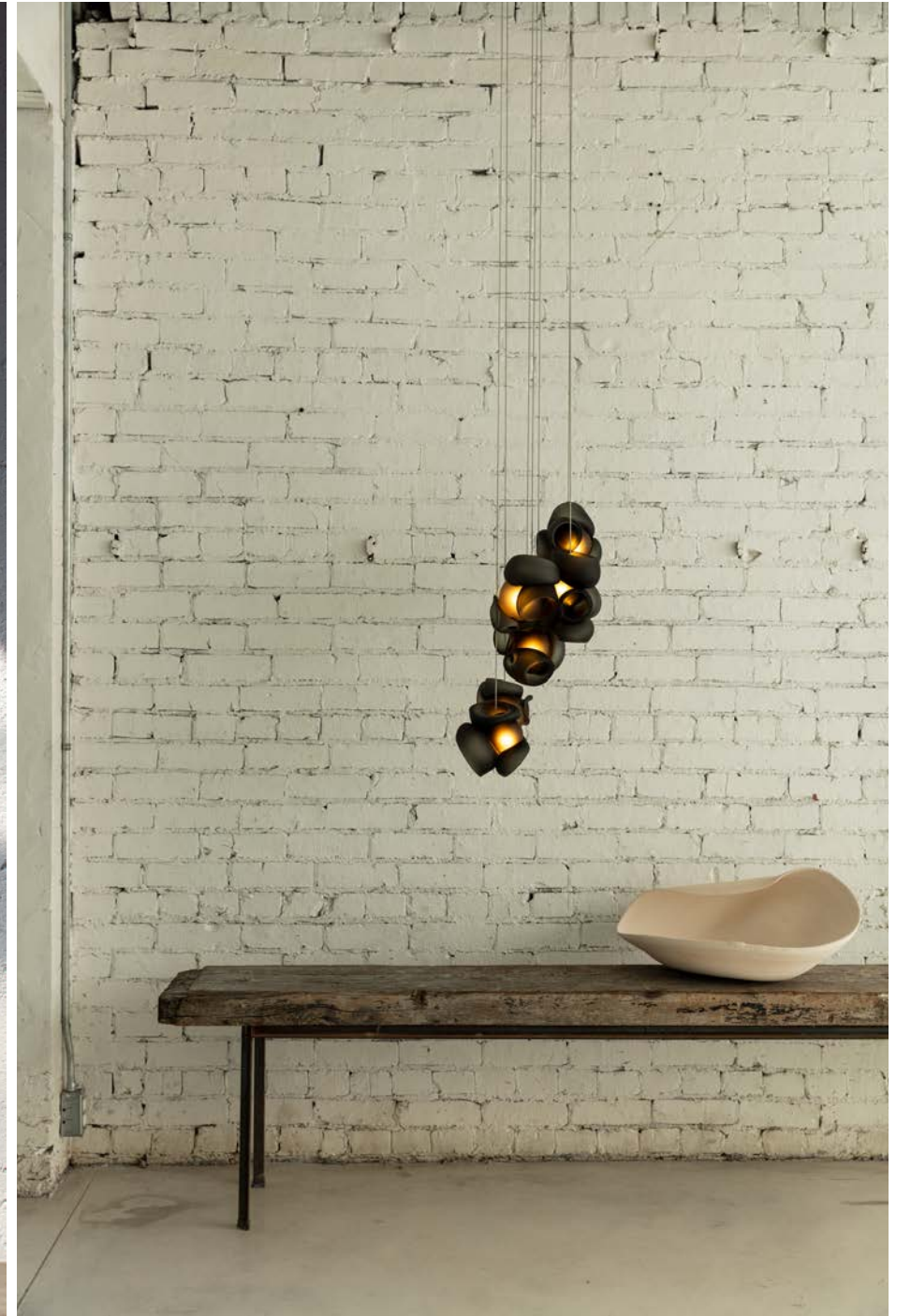



Table Light

A variety of Bocci pendants can be used with the table light hardware, which includes an integral dimming system housed within a sleek brass cylinder. The black fabric cord is semi-rigid and may be sculpted to add form. The brass stand has a small notch on the underside, allowing it to be hung on a wall if desired.

100t



28t



38vt



57t



73t



84t

Lamping

1.5w LED

Material

glass, black flexible cord with brass base and dial control



28t



38vt



57t



84t



73t

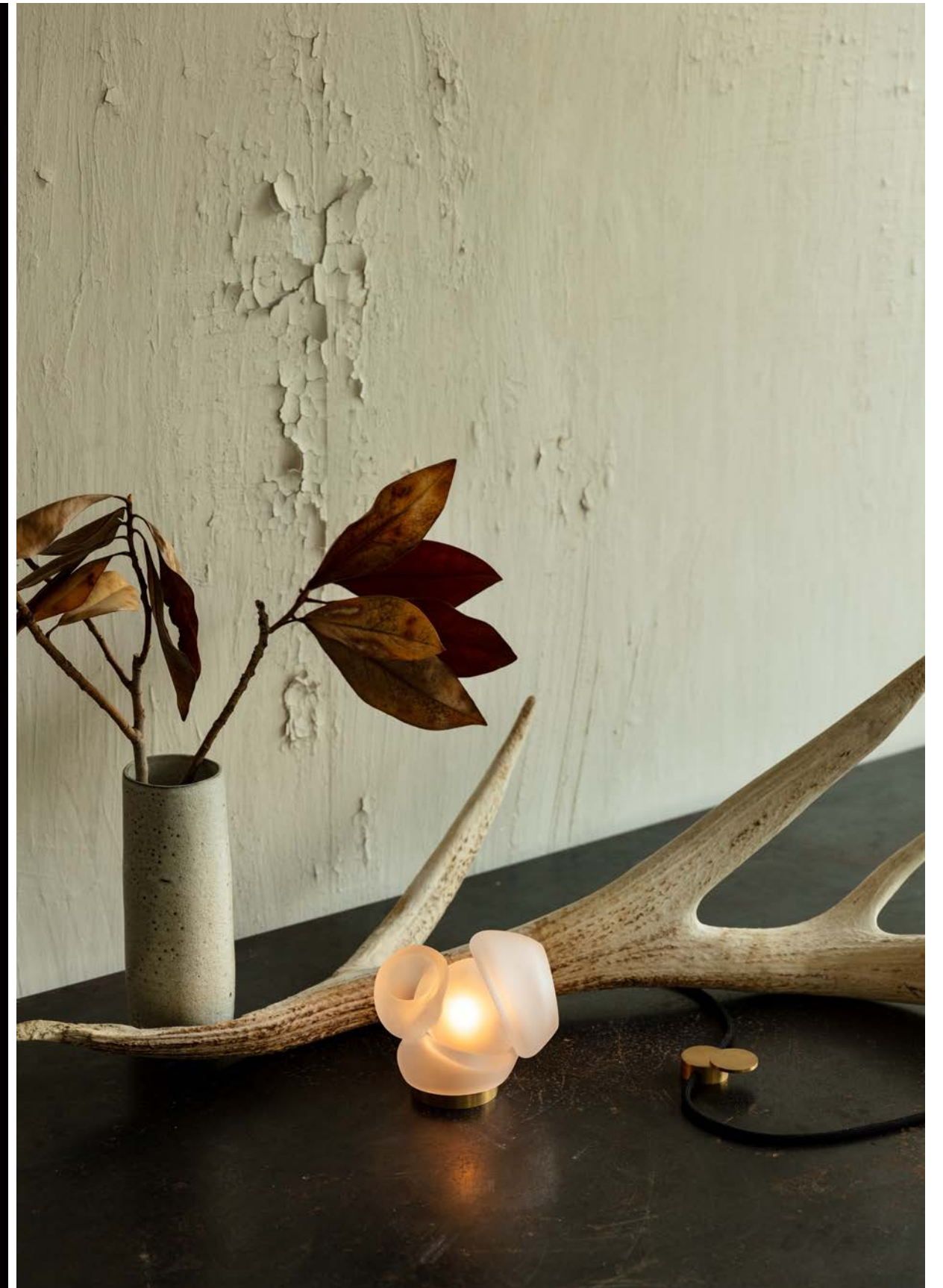

100t

Stem

The stem system allows for floor, ceiling or columnar installation. Columnar installation available as a a spring-loaded floor to ceiling application. Floor version can be plugged into a wall outlet for maximum flexibility. All versions include integral dimming system. Available in black or brass finish with a variety of pendant options.



Lamping

1.5w LED

Material

glass, black flexible cord and dial control



28 column



28 suspended



28 floor



57 floor



57 suspended



73 floor



38V floor



84 suspended



84 floor

Canopy

Single pendants

XX.1



Left: mini innie
Right: mini outie

Adjustable lengths canopy

XX.1 - XX.9

Left: brushed nickel, random configuration
Right: white, cluster configuration



Fixed lengths canopy

XX.11 - XX.50

Below: white, random configuration



Power Supply

Transformer

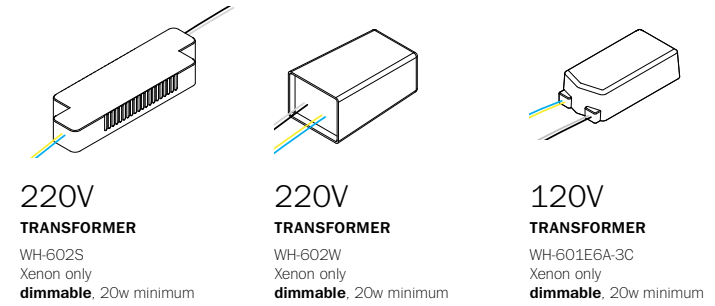

220V TRANSFORMER
WH-602S
Xenon only
dimable, 20w minimum

220V TRANSFORMER
WH-602W
Xenon only
dimable, 20w minimum

120V TRANSFORMER
WH-601E6A-3C
Xenon only
dimable, 20w minimum

Driver

dimmable

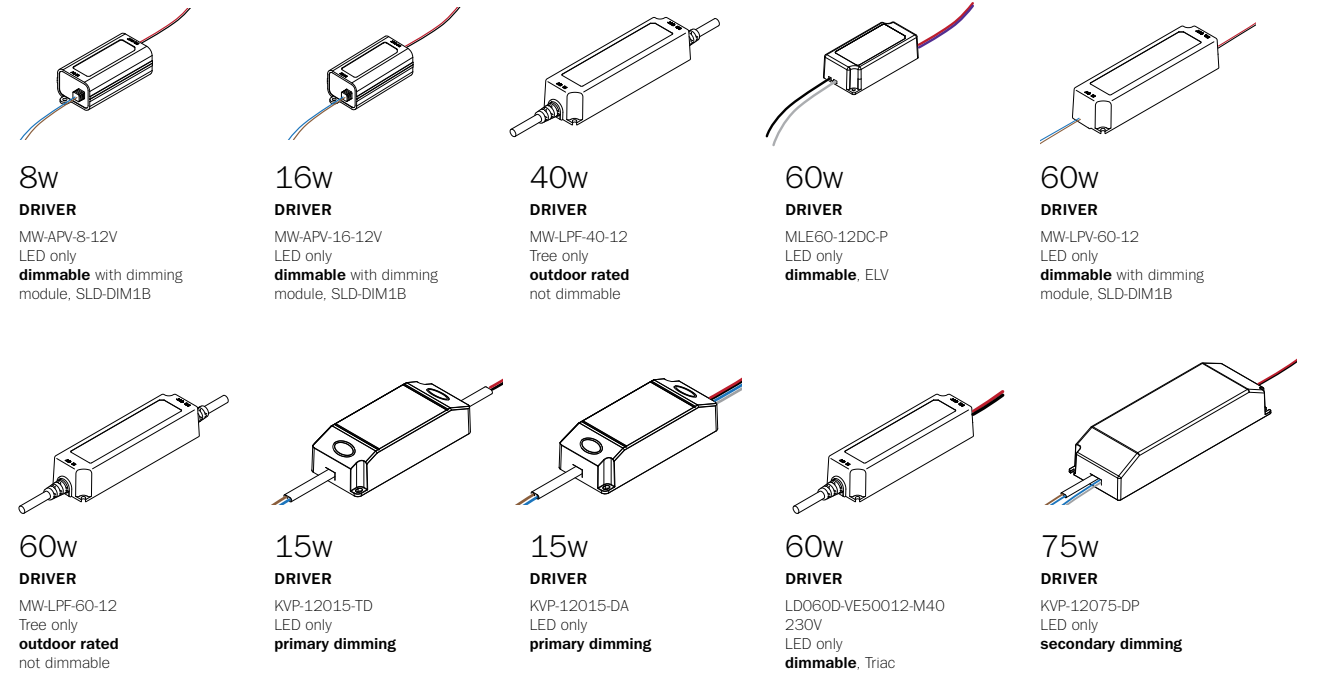

8w DRIVER
MW-APV-8-12V
LED only
dimable with dimming module, SLD-DIM1B

16w DRIVER
MW-APV-16-12V
LED only
dimable with dimming module, SLD-DIM1B

40w DRIVER
MW-LPF-40-12
Tree only
outdoor rated
not dimmable

60w DRIVER
MLE60-12DC-P
LED only
dimable, ELV

60w DRIVER
MW-LPV-60-12
LED only
dimable with dimming module, SLD-DIM1B

60w DRIVER
MW-LPF-60-12
Tree only
outdoor rated
not dimmable

15w DRIVER
KVP-12015-TD
LED only
primary dimming

15w DRIVER
KVP-12015-DA
LED only
primary dimming

60w DRIVER
LD060D-VE50012-M40
230V
LED only
dimable, Triac

75w DRIVER
KVP-12075-DP
LED only
secondary dimming

Dimming Module

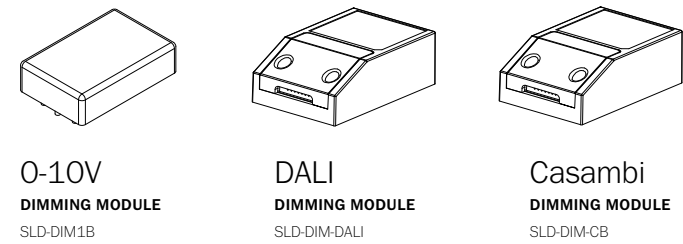

0-10V DIMMING MODULE
SLD-DIM1B

DALI DIMMING MODULE
SLD-DIM-DALI

Casambi DIMMING MODULE
SLD-DIM-CB

Objects



64

19.2

84.2

31.3 89

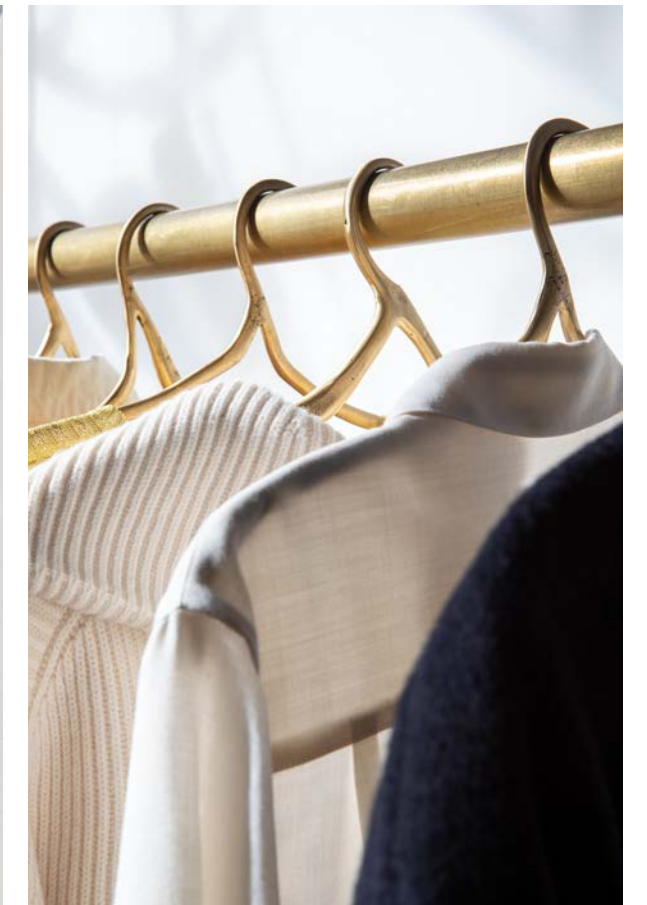

19.2

Overspill Brass Vessel

19.2 is an exploration of sand casting technique where a generous and unpredictable overspill is encouraged at the rim of each piece, making each iteration completely unique. The overspill oxidizes instantly producing a highly textured surface that stands in contrast to the interior of the piece, which is hand-polished to a near mirror finish.

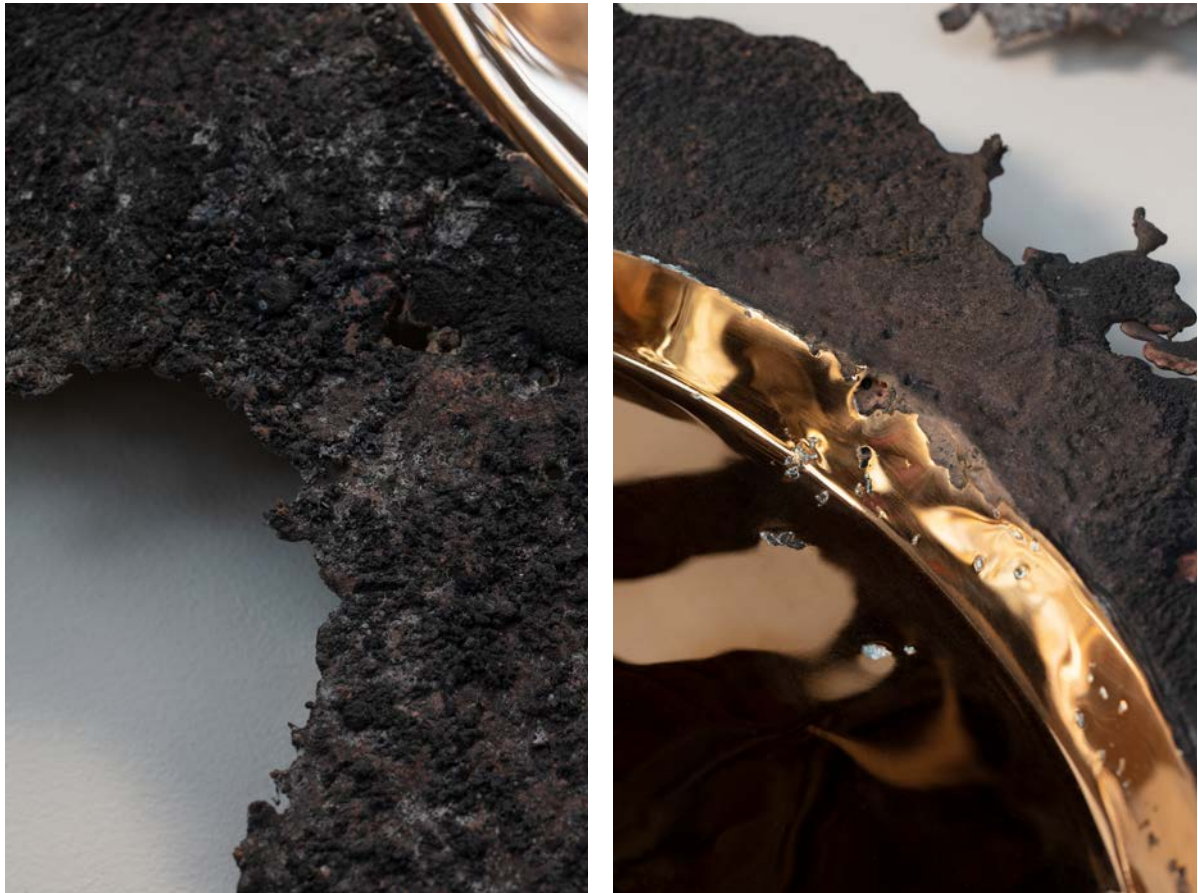

31.3

Polygon Glassware

31.3 is a group of 41, 18, or 8 individual glass elements designed to be arranged into compositions. The departure points for the project are twofold: a mathematical query into geometric tiling on the one hand, and the investigation of ancient colour formulas in Czech glassmaking on the other.



Beeswax Candles

64 is a project in which the solid and liquid states of wax and water are organized into a kind of choreography. Molten beeswax is allowed to cool around a wick inside a centrifugal chamber filled with shards of ice, creating a very delicate radial filigree of wax tendrils. Transportation of this delicate artifact is near impossible, so the candle is cast into a protective cube of ice that is allowed to melt only once the candle has reached its final destination. Thus, the act of burning the candle becomes but one of many chapters in the ritual of its making, transport, and eventual disintegration.



84.2

Copper Mesh Glass Vase

84.2 is created by suspending a bubble of white or coloured glass within a fine copper mesh basket that is then plunged into hot clear glass. Air is blown into the matrix to gently push the white or coloured glass through the mesh, creating a delicate pillowed form that rests inside the thick outer layer of clear glass. Undulations in the exterior shape are a natural consequence of the fabrication process and differ in each iteration of the procedure. The aperture is flared open, cut and finished, allowing the piece to function as a vase, and expressing the unique and specific outline of the copper mesh along the perimeter.

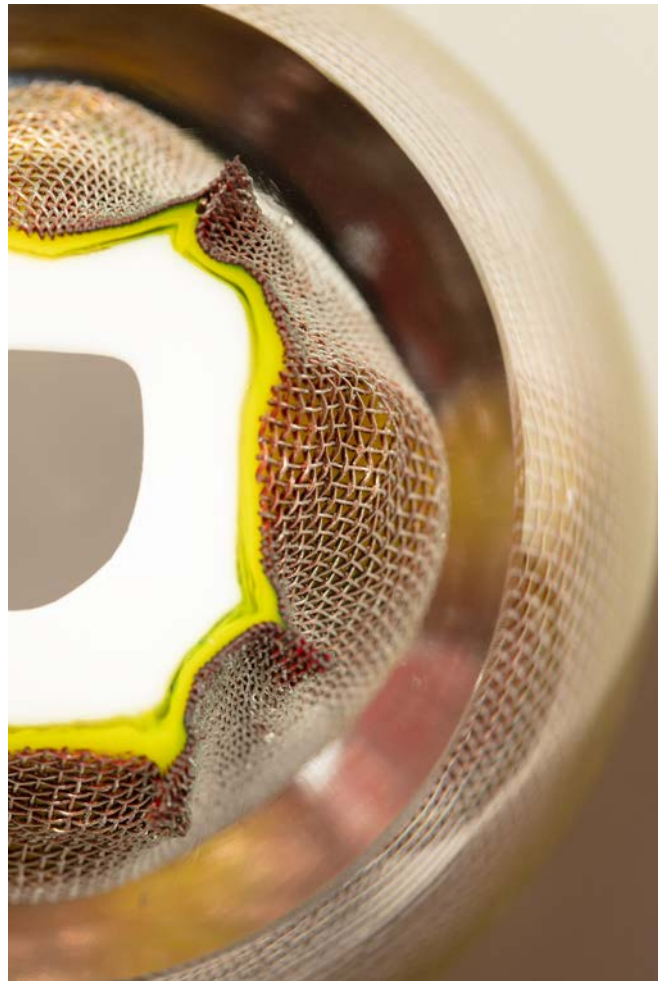

89

Hanger

89 hangers result from a scanning process that manipulates everyday objects to reveal organic sculptural forms. The distorted digital representations generated by this scanner are used to create a mould cavity out of sand, which molten brass is then poured into. The sand casting process is inaccurate by nature, further intensifying the uniqueness of each individual piece.



sales@bocci.com
info@bocci.com

[@bocci](#)
bocci.com