



# FLEXALIGHTING

smart  
news  
2023



FLUSH OPTIC  
DOWNLIGHTS



RECESSED OPTIC  
DOWNLIGHTS



TRIMLESS  
DOWNLIGHTS



TRIMLESS  
PROJECTORS



SEMI - RECESSED  
PROJECTORS



SURFACE  
PROJECTORS



LINEAR  
SYSTEMS



CEILING  
MOUNTED

# FLEXALIGHTING

## Alphabetical index

- ▶ Baba
- ▶ Elf
- ▶ Gagarin T
- ▶ Jos F
- ▶ Jos T
- ▶ Jos TP
- ▶ Lad F
- ▶ Leaf
- ▶ Leaf UGR
- ▶ Minijos F
- ▶ Minijos R
- ▶ Minijos S
- ▶ Zero

### FLUSH OPTIC DOWNLIGHTS

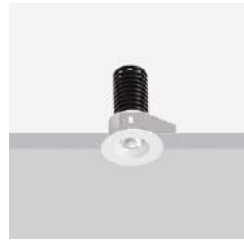

**LEAF 6**  
6W IP44



**LEAF 10**  
10W IP44

### RECESSED OPTIC DOWNLIGHTS



**BABA R10**  
10W IP44



**LEAF 6 UGR**  
6W IP44



**LEAF 10 UGR**  
10W IP44

### TRIMLESS DOWNLIGHTS



**ZERO R10**  
10W IP44

### TRIMLESS PROJECTORS

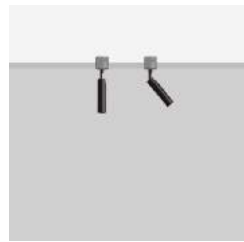

**MINIJOS F2**  
2W IP20



**MINIJOS F6**  
6W IP20



**MINIJOS F10**  
10W IP20

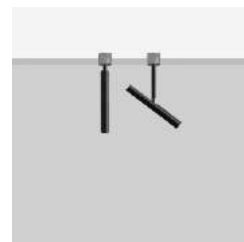

**JOS F2**  
2W IP20



**JOS F6**  
6W IP20



**JOS F10**  
10W IP20

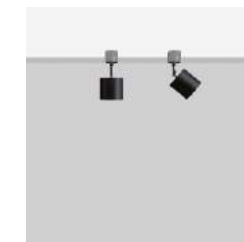

**LAD F6**  
6W IP20



**LAD F10**  
10W IP20

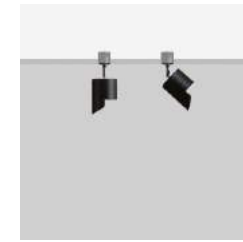

**LAD F10 WW**  
10W IP20

### SEMI-RECESSED PROJECTORS

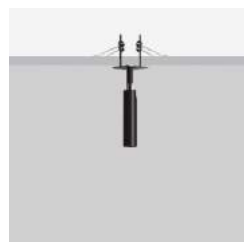

**MINIJOS R2**  
2W IP20

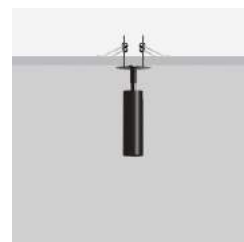

**MINIJOS R6**  
6W IP20



**MINIJOS R10**  
10W IP20

### SURFACE PROJECTORS



**MINIJOS S2**  
2W IP20



**MINIJOS S6**  
6W IP20



**MINIJOS S10**  
10W IP20

## LYNEAR SYSTEM



**JOS T2**  
2W IP20



**JOS T6**  
6W IP20



**JOS T10**  
10W IP20



**JOS T2P**  
2W IP20



**JOS T6P**  
6W IP20



**JOS T10P**  
10W IP20



**GAGARIN T2**  
2W IP20



**GAGARIN T6**  
6W IP20



**GAGARIN T10**  
10W IP20

## CEILING MOUNTED

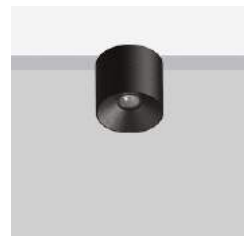

**ELF 2**  
1-2W IP65



**ELF 6**  
3-6W IP65



**ELF 10**  
10W IP65



**ELF 724**  
7W IP65

# LEAF 6

design: Roberto Mantovani

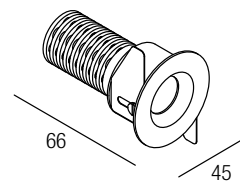

### Supply current

Alimentazione  
Courant d'alimentation  
Stromversorgung  
Corriente de alimentación

500 mA (V<sub>i</sub> 9V)

### Power

Potenza  
Puissance  
Bestuekung  
Potencia

6 W

### Series wiring

Cablaggio in serie  
Câblage en série  
Verkabelung in Serie  
Cableado en serie



### CCT/CRI/Flux

2700K — 540 lm  
3000K — 600 lm  
4000K — 620 lm

### CRI98

2-Step MacAdam

### Photometric diagrams

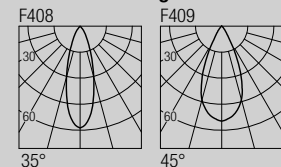

### Code Construction

Costruzione del codice - Construction du code produit  
Bau der Produkt-Code - Construcción del código de producto

### LF6 X X X

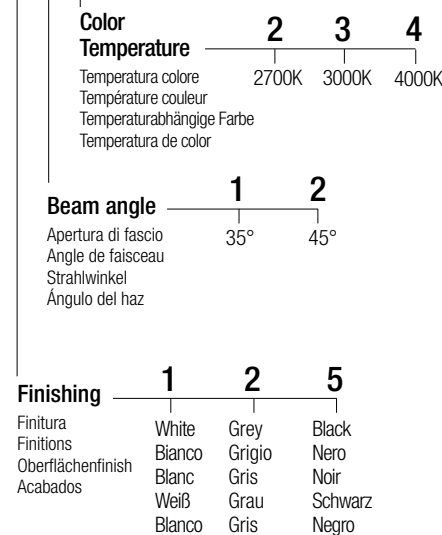

### Drivers

Alimentatori - Alimentateurs  
Netzteile - Alimentadores

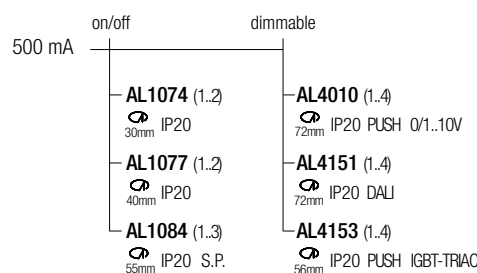

[DATASHEET](#) [INSTALLATION MANUAL](#)

[CERTIFICATIONS](#) [LDT-IES](#) [DRAWINGS](#)

# LEAF 10

design: Roberto Mantovani

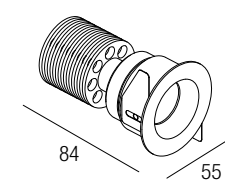

### Supply current

Alimentazione  
Courant d'alimentation  
Stromversorgung  
Corriente de alimentación

500 mA (V<sub>i</sub> 9V)

### Power

Potenza  
Puissance  
Bestuekung  
Potencia

10 W

### Series wiring

Cablaggio in serie  
Câblage en série  
Verkabelung in Serie  
Cableado en serie



### CCT/CRI/Flux

CRI85 CRI93  
2700K — 890lm 840lm  
3000K — 1000lm 930lm  
4000K — 1040lm 960lm

### CRI85-93

2-Step MacAdam

### Photometric diagrams

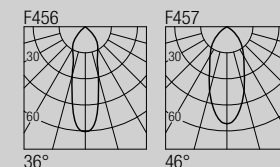

### Code Construction

Costruzione del codice - Construction du code produit  
Bau der Produkt-Code - Construcción del código de producto

### LF1 X X X X

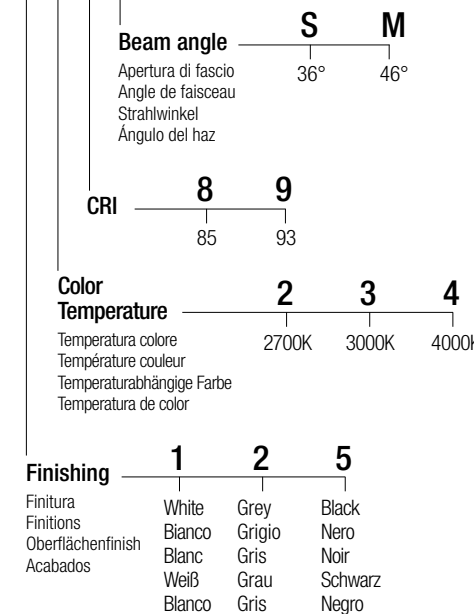

### Drivers

Alimentatori - Alimentateurs  
Netzteile - Alimentadores

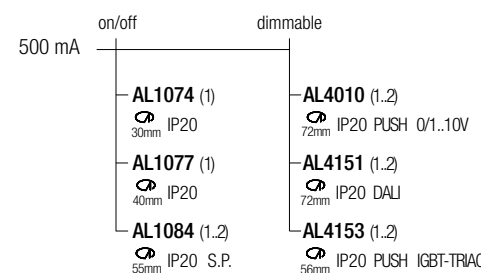

### Accessories

Accessori - Accessoires  
Zubehör - Accesorios

### LLF601

Low luminance louver  
Filtro antiabbagliamento  
Filtre basse luminance  
Geringe Leuchtdichte-Filter  
Filtro de baja luminancia

### SLF601

Milky screen  
Schermo opale  
Écran opale  
Opal-Bildschirm  
Pantalla opal

**Note:** the filter and the screen must be ordered together with the lighting fixture - **Nota:** il filtro e lo schermo devono essere ordinati congiuntamente all'apparecchio - **Note:** le filtre et l'écran doivent être commandées en même temps que l'appareil  
**Anmerkung:** müssen der Filter und der Bildschirm zusammen mit Leuchtkörper bestellt werden  
**Nota:** el filtro y la pantalla deben pedirse juntos con la luminaria

### AL7022

24VDC/500mA constant current converter  
Convertitore 24VDC/500mA corrente costante  
Convertisseur 24VDC/500mA courant constant  
24VDC/500mA konstanter Strom konverter  
Convertidor 24VDC/500mA corriente constante

[DATASHEET](#) [INSTALLATION MANUAL](#)

[CERTIFICATIONS](#) [LDT-IES](#) [DRAWINGS](#)

### Accessories

Accessori - Accessoires  
Zubehör - Accesorios

### LLF101

Low luminance louver  
Filtro antiabbagliamento  
Filtre basse luminance  
Geringe Leuchtdichte-Filter  
Filtro de baja luminancia

### SLF101

Milky screen  
Schermo opale  
Écran opale  
Opal-Bildschirm  
Pantalla opal

**Note:** the filter and the screen must be ordered together with the lighting fixture - **Nota:** il filtro e lo schermo devono essere ordinati congiuntamente all'apparecchio - **Note:** le filtre et l'écran doivent être commandées en même temps que l'appareil  
**Anmerkung:** müssen der Filter und der Bildschirm zusammen mit Leuchtkörper bestellt werden  
**Nota:** el filtro y la pantalla deben pedirse juntos con la luminaria

### AL7022

24VDC/500mA constant current converter  
Convertitore 24VDC/500mA corrente costante  
Convertisseur 24VDC/500mA courant constant  
24VDC/500mA konstanter Strom konverter  
Convertidor 24VDC/500mA corriente constante



# BABA R10

design: Roberto Mantovani

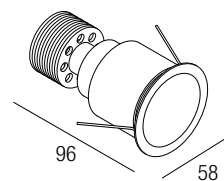

### Supply current

Alimentazione  
Courant d'alimentation  
Stromversorgung  
Corriente de alimentación  
**500 mA (V<sub>I</sub> 18V)**

### Power

Potenza  
Puissance  
Bestuekung  
Potencia  
**10 W**

### Series wiring

Cablaggio in serie  
Câblage en série  
Verkabelung in Serie  
Cableado en serie



### Photometric diagrams

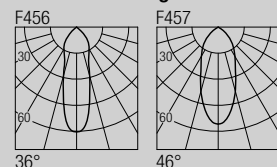

### CCT/CRI/Flux

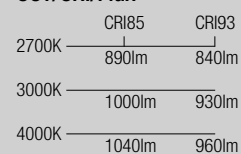

### CRI85-93

2-Step MacAdam

### Code Construction

Costruzione del codice - Construction du code produit  
Bau der Produkt-Code - Construcción del código de producto

## BAR1 X X X X

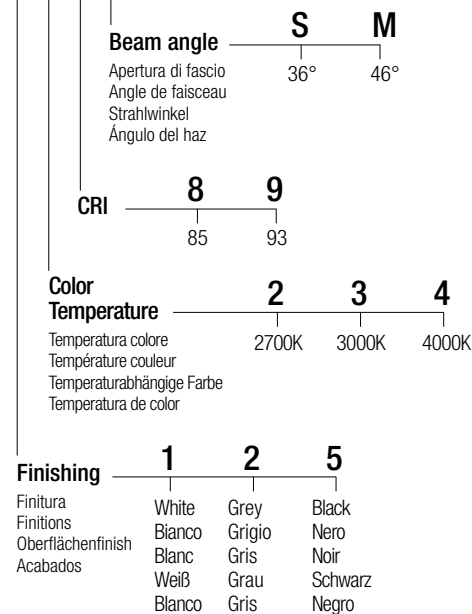

### Accessories

Accessori - Accessoires  
Zubehör - Accesorios

### CSBT10

Recessing box  
Controcassa  
Boîtier d'encastrement  
Eingießgehäuse  
Caja de empotrar

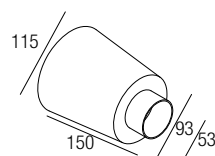

### LBAR101

Low luminance louver  
Filtro antiabbagliamento  
Filtre basse luminance  
Geringe Leuchtdichte-Filter  
Filtro de baja luminancia



### SBAR101

Milky screen  
Schermo opale  
Écran opale  
Opal-Bildschirm  
Pantalla opal



**Note:** the filter and the screen must be ordered together with the lighting fixture - **Nota:** il filtro e lo schermo devono essere ordinati congiuntamente all'apparecchio - **Note:** le filtre et l'écran doivent être commandées en même temps que l'appareil  
**Anmerkung:** müssen der Filter und der Bildschirm zusammen mit Leuchtkörper bestellt werden  
**Nota:** el filtro y la pantalla deben pedirse juntos con la luminaria

### AL7022

24VDC/500mA constant current converter  
Convertitore 24VDC/500mA corrente costante  
Convertisseur 24VDC/500mA courant constant  
24VDC/500mA konstanter Strom konverter  
Convertidor 24VDC/500mA corriente constante

### Drivers

Alimentatori - Alimentateurs  
Netzteile - Alimentadores

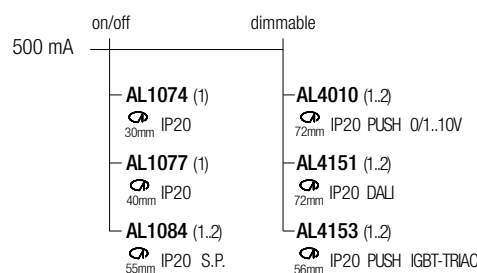

# LEAF 6 UGR

design: Roberto Mantovani

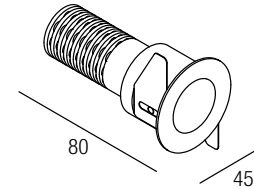

### Supply current

Alimentazione  
Courant d'alimentation  
Stromversorgung  
Corriente de alimentación  
**500 mA (V<sub>I</sub> 9V)**

### Power

Potenza  
Puissance  
Bestuekung  
Potencia  
**6 W**

### Series wiring

Cablaggio in serie  
Câblage en série  
Verkabelung in Serie  
Cableado en serie



### Photometric diagrams

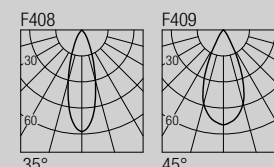

### CCT/CRI/Flux

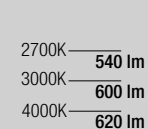

### CRI98

2-Step MacAdam

### Code Construction

Costruzione del codice - Construction du code produit  
Bau der Produkt-Code - Construcción del código de producto

## LFU6 X X X

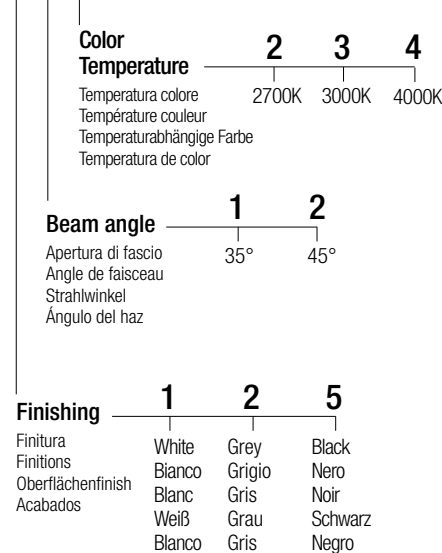

### Accessories

Accessori - Accessoires  
Zubehör - Accesorios

### LLFU601

Low luminance louver  
Filtro antiabbagliamento  
Filtre basse luminance  
Geringe Leuchtdichte-Filter  
Filtro de baja luminancia



### SLFU601

Milky screen  
Schermo opale  
Écran opale  
Opal-Bildschirm  
Pantalla opal



**Note:** the filter and the screen must be ordered together with the lighting fixture - **Nota:** il filtro e lo schermo devono essere ordinati congiuntamente all'apparecchio - **Note:** le filtre et l'écran doivent être commandées en même temps que l'appareil  
**Anmerkung:** müssen der Filter und der Bildschirm zusammen mit Leuchtkörper bestellt werden  
**Nota:** el filtro y la pantalla deben pedirse juntos con la luminaria

### AL7022

24VDC/500mA constant current converter  
Convertitore 24VDC/500mA corrente costante  
Convertisseur 24VDC/500mA courant constant  
24VDC/500mA konstanter Strom konverter  
Convertidor 24VDC/500mA corriente constante

### Drivers

Alimentatori - Alimentateurs  
Netzteile - Alimentadores

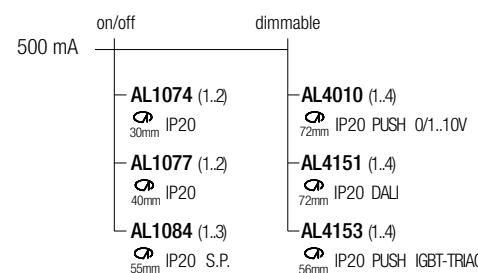

# LEAF 10 UGR

design: Roberto Mantovani

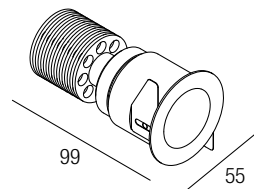

### Supply current

Alimentazione  
Courant d'alimentation  
Stromversorgung  
Corriente de alimentación  
**500 mA (V<sub>i</sub> 9V)**

### Power

Potenza  
Puissance  
Bestuekung  
Potencia  
**10 W**

### Series wiring

Cablaggio in serie  
Câblage en série  
Verkabelung in Serie  
Cableado en serie



### Photometric diagrams

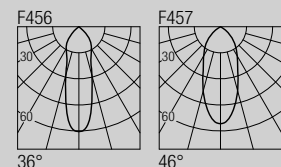

### CCT/CRI/Flux

CCT	CRI85	CRI93
2700K	890lm	840lm
3000K	1000lm	930lm
4000K	1040lm	960lm

### CRI85-93

2-Step MacAdam

### Code Construction

Costruzione del codice - Construction du code produit  
Bau der Produkt-Code - Construcción del código de producto

### LFU1 X X X X

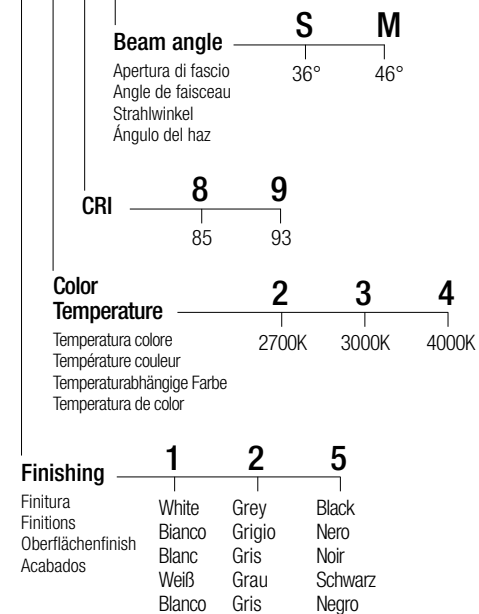

# ZERO R10

design: Roberto Mantovani

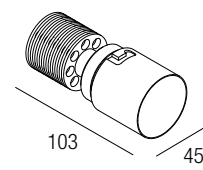

### Supply current

Alimentazione  
Courant d'alimentation  
Stromversorgung  
Corriente de alimentación  
**500 mA (V<sub>i</sub> 18V)**

### Power

Potenza  
Puissance  
Bestuekung  
Potencia  
**10 W**

### Series wiring

Cablaggio in serie  
Câblage en série  
Verkabelung in Serie  
Cableado en serie



### Photometric diagrams

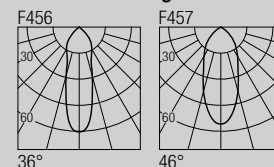

### CCT/CRI/Flux

CCT	CRI85	CRI93
2700K	890lm	840lm
3000K	1000lm	930lm
4000K	1040lm	960lm

### CRI85-93

2-Step MacAdam

### Code Construction

Costruzione del codice - Construction du code produit  
Bau der Produkt-Code - Construcción del código de producto

### ZR1 X X X X

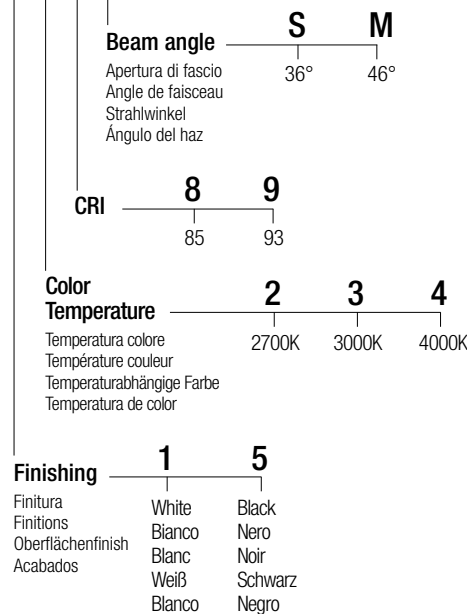

### Accessories

Accessori - Accessoires  
Zubehör - Accesorios

### LLFU101

Low luminance louver  
Filtro antiabbagliamento  
Filtre basse luminance  
Geringe Leuchtdichte-Filter  
Filtro de baja luminancia

### SLFU101

Milky screen  
Schermo opale  
Écran opale  
Opal-Bildschirm  
Pantalla opal

**Note:** the filter and the screen must be ordered together with the lighting fixture - **Nota:** il filtro e lo schermo devono essere ordinati congiuntamente all'apparecchio - **Note:** le filtre et l'écran doivent être commandées en même temps que l'appareil  
**Anmerkung:** müssen der Filter und der Bildschirm zusammen mit Leuchtkörper bestellt werden  
**Nota:** el filtro y la pantalla deben pedirse juntos con la luminaria

### AL7022

24VDC/500mA constant current converter  
Convertitore 24VDC/500mA corrente costante  
Convertisseur 24VDC/500mA courant constant  
24VDC/500mA konstanter Strom konverter  
Convertidor 24VDC/500mA corriente constante

### Accessories

Accessori - Accessoires  
Zubehör - Accesorios

### ZTC05U ZTC05UB

White Black  
Bianco Nero  
Blanc Noir  
Weiß Schwarz  
Blanco Negro

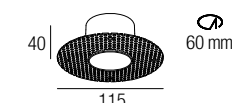

Plasterboard recessing frame  
Flangia per cartongesso  
Boîtier d'encastrement pour plaques de plâtre  
Gehäuses Trockenbau  
Cajetín para placas de yeso

### LZR101

Low luminance louver  
Filtro antiabbagliamento  
Filtre basse luminance  
Geringe Leuchtdichte-Filter  
Filtro de baja luminancia

### SZR101

Milky screen  
Schermo opale  
Écran opale  
Opal-Bildschirm  
Pantalla opal

**Note:** the filter and the screen must be ordered together with the lighting fixture - **Nota:** il filtro e lo schermo devono essere ordinati congiuntamente all'apparecchio - **Note:** le filtre et l'écran doivent être commandées en même temps que l'appareil  
**Anmerkung:** müssen der Filter und der Bildschirm zusammen mit Leuchtkörper bestellt werden  
**Nota:** el filtro y la pantalla deben pedirse juntos con la luminaria

### AL7022

24VDC/500mA constant current converter  
Convertitore 24VDC/500mA corrente costante  
Convertisseur 24VDC/500mA courant constant  
24VDC/500mA konstanter Strom konverter  
Convertidor 24VDC/500mA corriente constante

### Drivers

Alimentatori - Alimentateurs  
Netzteile - Alimentadores

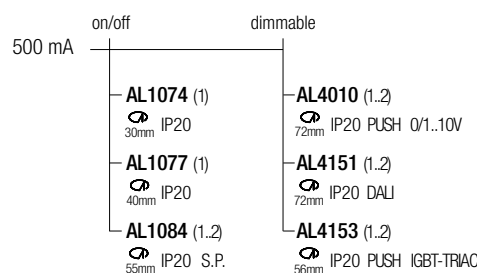

### Drivers

Alimentatori - Alimentateurs  
Netzteile - Alimentadores

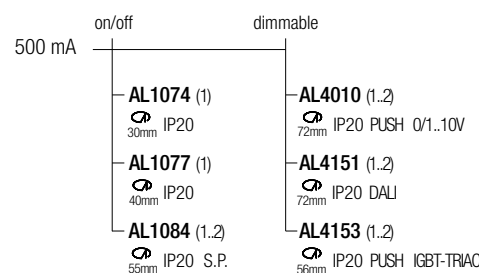

# MINIJOS F2

design: Roberto Mantovani

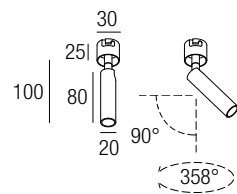

### Supply current

Alimentazione  
Courant d'alimentation  
Stromversorgung  
Corriente de alimentación  
**500 mA (V<sub>i</sub> 2,9V)**

### Power

Potenza  
Puissance  
Bestuekung  
Potencia  
**2 W**

### Series wiring

Cablaggio in serie  
Câblage en série  
Verkabelung in Serie  
Cableado en serie



### CCT/CRI/Flux

#### Photometric diagrams

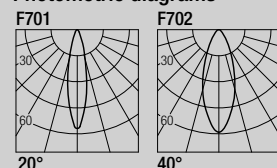

2700K — 128 lm  
3000K — 133 lm  
4200K — 154 lm

### CRI85

2-Step MacAdam

### Code Construction

Costruzione del codice - Construction du code produit  
Bau der Produkt-Code - Construcción del código de producto

### MJSF2 X X X

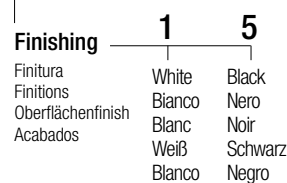
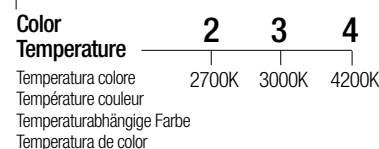
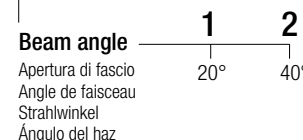

### Drivers

Alimentatori - Alimentateurs  
Netzteile - Alimentadores

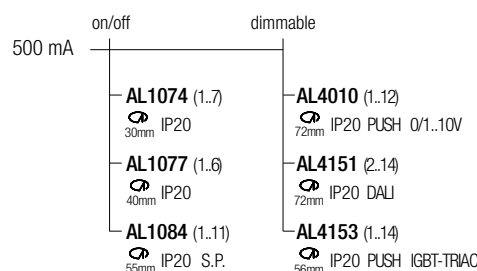

# MINIJOS F6

design: Roberto Mantovani

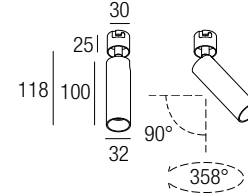

### Supply current

Alimentazione  
Courant d'alimentation  
Stromversorgung  
Corriente de alimentación  
**500 mA (V<sub>i</sub> 9V)**

### Power

Potenza  
Puissance  
Bestuekung  
Potencia  
**6 W**

### Series wiring

Cablaggio in serie  
Câblage en série  
Verkabelung in Serie  
Cableado en serie



### CCT/CRI/Flux

#### Photometric diagrams

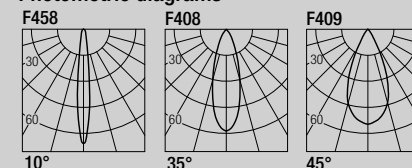

2700K — 540 lm  
3000K — 600 lm  
4000K — 620 lm

### CRI98

2-Step MacAdam

### Code Construction

Costruzione del codice - Construction du code produit  
Bau der Produkt-Code - Construcción del código de producto

### MJSF6 X X X

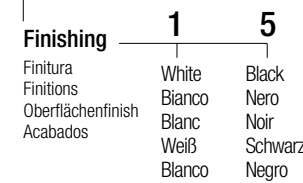
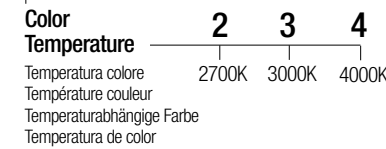
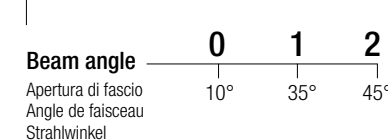

### Drivers

Alimentatori - Alimentateurs  
Netzteile - Alimentadores

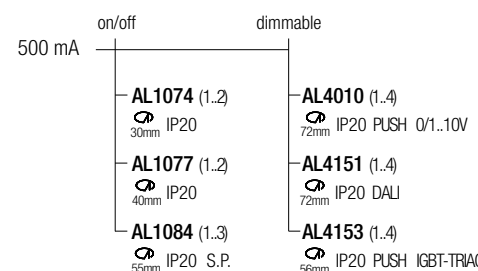

### Accessories

Accessori - Accessoires  
Zubehör - Accesorios

### ZQC001 ZQC001B

White  
Bianco  
Blanc  
Weiß  
Blanco

Black  
Nero  
Noir  
Schwarz  
Negro

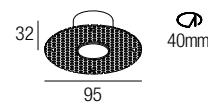

Plasterboard recessing frame  
Flangia per cartongesso  
Boîtier d'encastrement pour plaques de plâtre  
Gehäuses Trockenbau  
Cajetín para placas de yeso

### AL7022

24VDC/500mA constant current converter  
Convertitore 24VDC/500mA corrente costante  
Convertisseur 24VDC/500mA courant constant  
24VDC/500mA konstanter Strom konverter  
Convertidor 24VDC/500mA corriente constante

**Note:** versions with extended arm length are available upon request **Nota:** versioni con lunghezza del braccetto maggiorata disponibili su richiesta **Note:** versions avec longueur du bras majorée disponibles sur demande **Anmerkung:** versionen mit erhöhter Armlänge auf Anfrage erhältlich **Nota:** Versiones con longitud del brazo aumentada disponible bajo pedido

### Accessories

Accessori - Accessoires  
Zubehör - Accesorios

### ZQC001 ZQC001B

White  
Bianco  
Blanc  
Weiß  
Blanco

Black  
Nero  
Noir  
Schwarz  
Negro



Plasterboard recessing frame  
Flangia per cartongesso  
Boîtier d'encastrement pour plaques de plâtre  
Gehäuses Trockenbau  
Cajetín para placas de yeso

### LJ02

White  
Bianco  
Blanc  
Weiß  
Blanco

### LJ02B

Black  
Nero  
Noir  
Schwarz  
Negro

Low luminance louver  
Filtro antiabbagliamento  
Filtre basse luminance  
Geringe Leuchtdichte-Filter  
Filtro de baja luminancia



### SJ02

White  
Bianco  
Blanc  
Weiß  
Blanco

### SJ02B

Black  
Nero  
Noir  
Schwarz  
Negro

Milky screen  
Schermo opale  
Écran opale  
Opal-Bildschirm  
Pantalla opal



### AL7022

24VDC/500mA constant current converter  
Convertitore 24VDC/500mA corrente costante  
Convertisseur 24VDC/500mA courant constant  
24VDC/500mA konstanter Strom konverter  
Convertidor 24VDC/500mA corriente constante

**Note:** versions with extended arm length are available upon request **Nota:** versioni con lunghezza del braccetto maggiorata disponibili su richiesta **Note:** versions avec longueur du bras majorée disponibles sur demande **Anmerkung:** versionen mit erhöhter Armlänge auf Anfrage erhältlich **Nota:** Versiones con longitud del brazo aumentada disponible bajo pedido



# MINIJOS F10

design: Roberto Mantovani

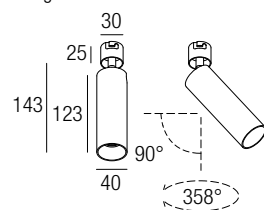

### Supply current

Alimentazione  
Courant d'alimentation  
Stromversorgung  
Corriente de alimentación

500 mA (V<sub>i</sub> 18V)

### Power

Potenza  
Puissance  
Bestuekung  
Potencia

10 W

### Series wiring

Cablaggio in serie  
Câblage en série  
Verkabelung in Serie  
Cableado en serie



### Photometric diagrams

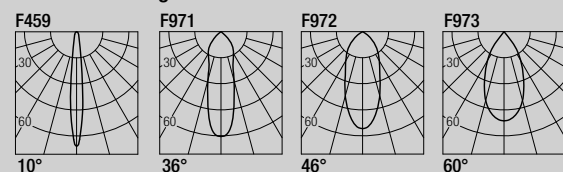

### CCT/CRI/Flux

	CRI85	CRI93
2700K	890lm	840lm
3000K	1000lm	930lm
4000K	1040lm	960lm

### CRI85-93

2-Step MacAdam



### Code Construction

Costruzione del codice - Construction du code produit  
Bau der Produkt-Code - Construcción del código de producto

### MJSF1 X X X X

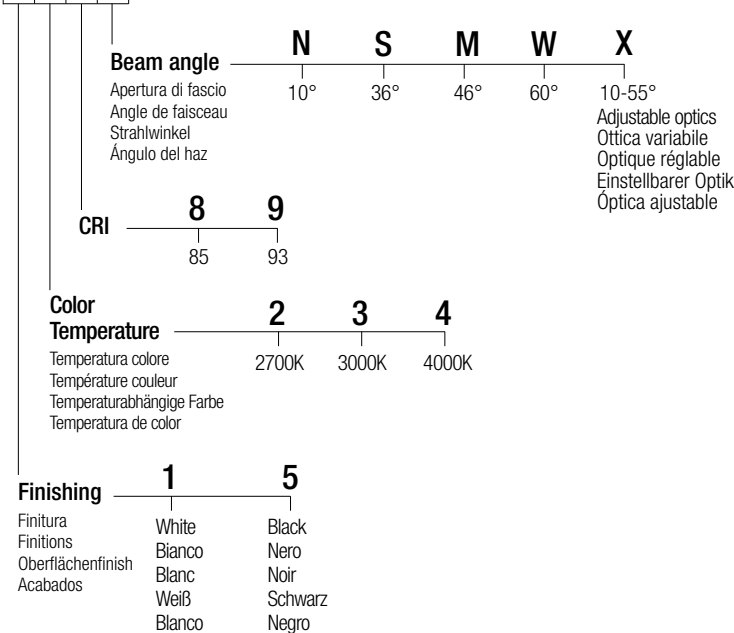

### Drivers

Alimentatori - Alimentateurs  
Netzteile - Alimentadores

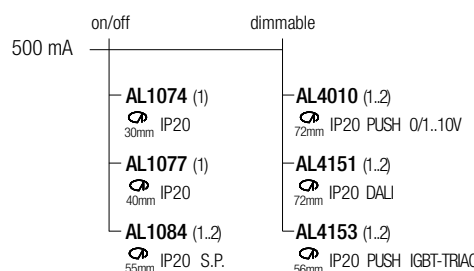

# JOS F2

design: Roberto Mantovani

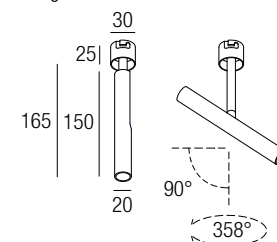

### Supply current

Alimentazione  
Courant d'alimentation  
Stromversorgung  
Corriente de alimentación

500 mA (V<sub>i</sub> 2,9V)

### Power

Potenza  
Puissance  
Bestuekung  
Potencia

2 W

### Series wiring

Cablaggio in serie  
Câblage en série  
Verkabelung in Serie  
Cableado en serie



### Photometric diagrams

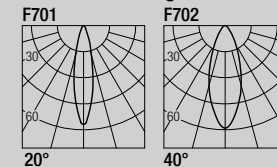

### CCT/CRI/Flux

2700K	128 lm
3000K	133 lm
4200K	154 lm

### CRI85

2-Step MacAdam



### Code Construction

Costruzione del codice - Construction du code produit  
Bau der Produkt-Code - Construcción del código de producto

### JSF2 X X X

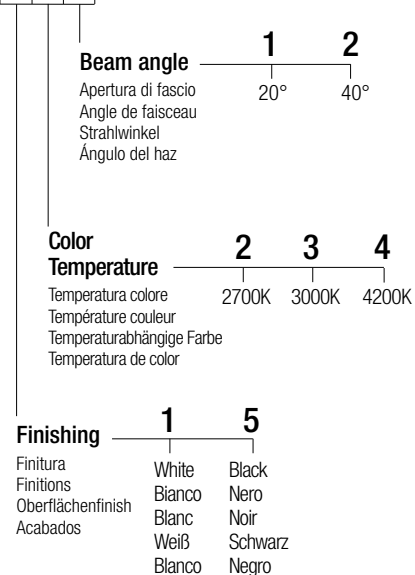

### Drivers

Alimentatori - Alimentateurs  
Netzteile - Alimentadores

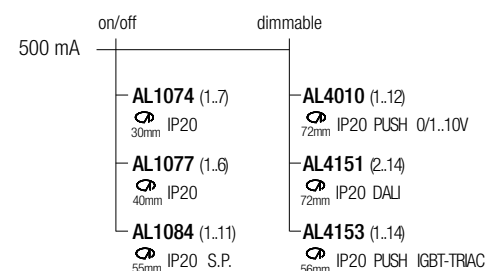

### Accessories

Accessori - Accessoires  
Zubehör - Accesorios

### ZQC001 ZQC001B

White  
Bianco  
Blanc  
Weiß  
Blanco

Black  
Nero  
Noir  
Schwarz  
Negro

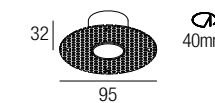

Plasterboard recessing frame  
Flangia per cartongesso  
Boîtier d'encastrement pour plaques de plâtre  
Gehäuses Trockenbau  
Cajetín para placas de yeso

### AL7022

24VDC/500mA constant current converter  
Convertitore 24VDC/500mA corrente costante  
Convertisseur 24VDC/500mA courant constant  
24VDC/500mA konstanter Strom konverter  
Convertidor 24VDC/500mA corriente constante

**Note:** versions with extended arm length are available upon request **Nota:** versioni con lunghezza del braccetto maggiorata disponibili su richiesta **Note:** versions avec longueur du bras majorée disponibles sur demande **Anmerkung:** versionen mit erhöhter Armlänge auf Anfrage erhältlich **Nota:** Versiones con longitud del brazo aumentada disponible bajo pedido

### Accessories

Accessori - Accessoires  
Zubehör - Accesorios

### ZQC001 ZQC001B

White  
Bianco  
Blanc  
Weiß  
Blanco

Black  
Nero  
Noir  
Schwarz  
Negro

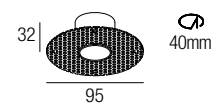

Plasterboard recessing frame  
Flangia per cartongesso  
Boîtier d'encastrement pour plaques de plâtre  
Gehäuses Trockenbau  
Cajetín para placas de yeso

### LJ01 LJ01B

White  
Bianco  
Blanc  
Weiß  
Blanco

Black  
Nero  
Noir  
Schwarz  
Negro

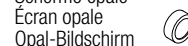

Low luminance louver  
Filtro antiabbagliamento  
Filtre basse luminance  
Geringe Leuchtdichte-Filter  
Filtro de baja luminancia

Milky screen  
Schermo opale  
Écran opale  
Opal-Bildschirm  
Pantalla opal

### AL7022

24VDC/500mA constant current converter  
Convertitore 24VDC/500mA corrente costante  
Convertisseur 24VDC/500mA courant constant  
24VDC/500mA konstanter Strom konverter  
Convertidor 24VDC/500mA corriente constante

**Note:** versions with extended arm length are available upon request **Nota:** versioni con lunghezza del braccetto maggiorata disponibili su richiesta **Note:** versions avec longueur du bras majorée disponibles sur demande **Anmerkung:** versionen mit erhöhter Armlänge auf Anfrage erhältlich **Nota:** Versiones con longitud del brazo aumentada disponible bajo pedido

# JOS F6

design: Roberto Mantovani

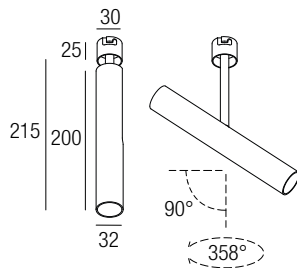

### Supply current

Alimentazione  
Courant d'alimentation  
Stromversorgung  
Corriente de alimentación  
**500 mA (V<sub>i</sub> 9V)**

### Power

Potenza  
Puissance  
Bestuekung  
Potencia  
**6 W**

### Series wiring

Cablaggio in serie  
Câblage en série  
Verkabelung in Serie  
Cableado en serie



### Photometric diagrams

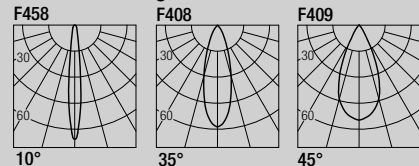

### CCT/CRI/Flux

2700K — 540 lm  
3000K — 600 lm  
4000K — 620 lm

CRI98  
2-Step MacAdam



# JOS F10

design: Roberto Mantovani

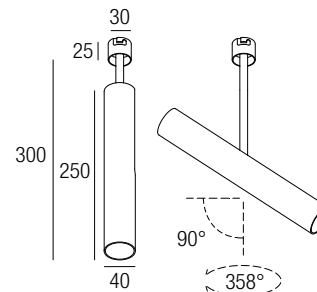

### Supply current

Alimentazione  
Courant d'alimentation  
Stromversorgung  
Corriente de alimentación  
**500 mA (V<sub>i</sub> 18V)**

### Power

Potenza  
Puissance  
Bestuekung  
Potencia  
**10 W**

### Series wiring

Cablaggio in serie  
Câblage en série  
Verkabelung in Serie  
Cableado en serie



### Photometric diagrams

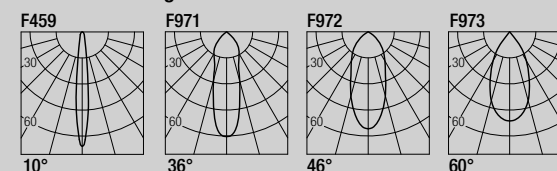

### CCT/CRI/Flux

CRI85 CRI93  
2700K — 890lm 840lm  
3000K — 1000lm 930lm  
4000K — 1040lm 960lm

CRI85-93  
2-Step MacAdam



### Code Construction

Costruzione del codice - Construction du code produit  
Bau der Produkt-Code - Construcción del código de producto

### JSF6 X X X

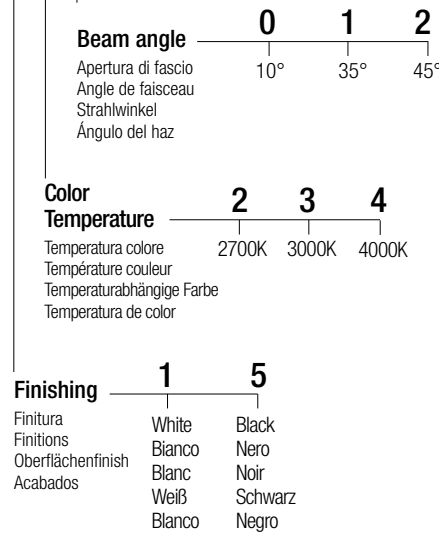

### Accessories

Accessori - Accessoires  
Zubehör - Accesorios

### ZQC001 ZQC001B

White Bianco  
Blanco Negro  
Weiß Schwarz  
Blanco Negro

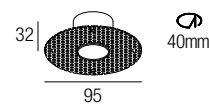

Plasterboard recessing frame  
Flangia per cartongesso  
Boîtier d'encastrement pour plaques de plâtre  
Gehäuses Trockenbau  
Cajetín para placas de yeso

### LJ02

White Bianco  
Blanco Negro  
Weiß Schwarz  
Blanco Negro

Low luminance louver  
Filtro antiabbagliamento  
Filtre basse luminance  
Geringe Leuchtdichte-Filter  
Filtro de baja luminancia

### LJ02B

Black Nero  
Noir Noir  
Schwarz Schwarz  
Negro Negro



Milky screen  
Schermo opale  
Écran opale  
Opal-Bildschirm  
Pantalla opal

**Note:** the filter and the screen are not available in adjustable optics version 10-55° - **Nota:** il filtro e lo schermo non sono disponibili nella versione ad ottica regolabile 10-55° - **Note:** le filtre et l'écran ne sont pas disponibles dans la version à optique réglable 10-55° - **Anmerkung:** Filter und Bildschirm sind in der einstellbaren optischen Version 10-55° nicht verfügbar - **Nota:** el filtro y la pantalla no están disponibles en la versión de óptica ajustable 10-55°

### AL7022

24VDC/500mA constant current converter  
Convertitore 24VDC/500mA corrente costante  
Convertisseur 24VDC/500mA courant constant  
24VDC/500mA konstanter Strom konverter  
Convertidor 24VDC/500mA corriente constante

**Note:** versions with extended arm length are available upon request **Nota:** versioni con lunghezza del braccetto maggiorata disponibili su richiesta **Note:** versions avec longueur du bras majorée disponibles sur demande **Anmerkung:** versionen mit erhöhter Armlänge auf Anfrage erhältlich **Nota:** Versiones con longitud del brazo aumentada disponible bajo pedido

### Code Construction

Costruzione del codice - Construction du code produit  
Bau der Produkt-Code - Construcción del código de producto

### JSF1 X X X X

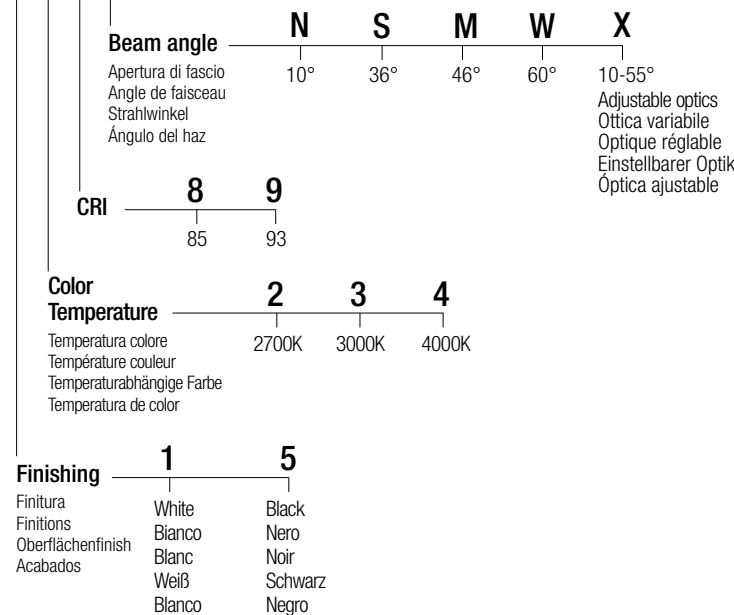

### Drivers

Alimentatori - Alimentateurs  
Netzteile - Alimentadores

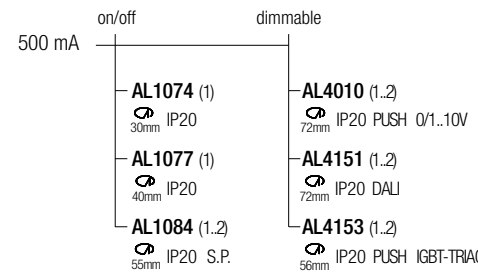

### Accessories

Accessori - Accessoires  
Zubehör - Accesorios

### ZQC001 ZQC001B

White Bianco  
Blanco Negro  
Weiß Schwarz  
Blanco Negro

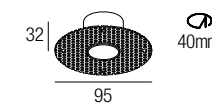

Plasterboard recessing frame  
Flangia per cartongesso  
Boîtier d'encastrement pour plaques de plâtre  
Gehäuses Trockenbau  
Cajetín para placas de yeso

### LJ01

White Bianco  
Blanco Negro  
Weiß Schwarz  
Blanco Negro

Low luminance louver  
Filtro antiabbagliamento  
Filtre basse luminance  
Geringe Leuchtdichte-Filter  
Filtro de baja luminancia

### LJ01B

Black Nero  
Noir Noir  
Schwarz Schwarz  
Negro Negro

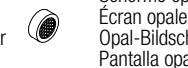

Milky screen  
Schermo opale  
Écran opale  
Opal-Bildschirm  
Pantalla opal

**Note:** the filter and the screen are not available in adjustable optics version 10-55° - **Nota:** il filtro e lo schermo non sono disponibili nella versione ad ottica regolabile 10-55° - **Note:** le filtre et l'écran ne sont pas disponibles dans la version à optique réglable 10-55° - **Anmerkung:** Filter und Bildschirm sind in der einstellbaren optischen Version 10-55° nicht verfügbar - **Nota:** el filtro y la pantalla no están disponibles en la versión de óptica ajustable 10-55°

### AL7022

24VDC/500mA constant current converter  
Convertitore 24VDC/500mA corrente costante  
Convertisseur 24VDC/500mA courant constant  
24VDC/500mA konstanter Strom konverter  
Convertidor 24VDC/500mA corriente constante

**Note:** versions with extended arm length are available upon request **Nota:** versioni con lunghezza del braccetto maggiorata disponibili su richiesta **Note:** versions avec longueur du bras majorée disponibles sur demande **Anmerkung:** versionen mit erhöhter Armlänge auf Anfrage erhältlich **Nota:** Versiones con longitud del brazo aumentada disponible bajo pedido

# LAD F6

design: Roberto Mantovani

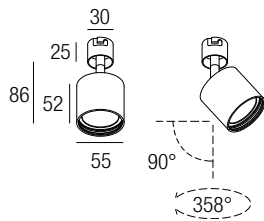

### Supply current

Alimentazione  
Courant d'alimentation  
Stromversorgung  
Corriente de alimentación  
**500 mA (V, 9V)**

### Power

Potenza  
Puissance  
Bestuekung  
Potencia  
**6 W**

### Series wiring

Cablaggio in serie  
Câblage en série  
Verkabelung in Serie  
Cableado en serie



### Photometric diagrams

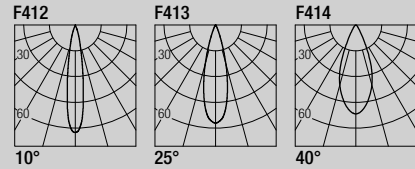

### CCT/CRI/Flux

2700K — 540 lm  
3000K — 600 lm  
4000K — 620 lm

**CRI98**  
2-Step MacAdam



# LAD F10

design: Roberto Mantovani

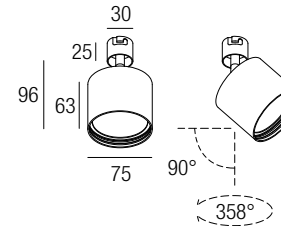

### Supply current

Alimentazione  
Courant d'alimentation  
Stromversorgung  
Corriente de alimentación  
**500 mA (V, 18V)**

### Power

Potenza  
Puissance  
Bestuekung  
Potencia  
**10 W**

### Series wiring

Cablaggio in serie  
Câblage en série  
Verkabelung in Serie  
Cableado en serie



### Photometric diagrams

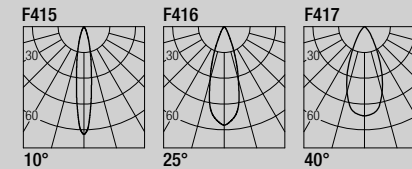

### CCT/CRI/Flux

2700K — CRI85 — 890lm  
3000K — CRI93 — 1000lm  
4000K — 1040lm

**CRI85-93**  
2-Step MacAdam



### Code Construction

Costruzione del codice - Construction du code produit  
Bau der Produkt-Code - Construcción del código de producto

## LADF6 X X X

**Beam angle** — 1 — 2 — 3  
Apertura di fascio — 10° — 25° — 40°  
Angle de faisceau  
Strahlwinkel  
Ángulo del haz

**Color Temperature** — 2 — 3 — 4  
Temperatura colore — 2700K — 3000K — 4000K  
Température couleur  
Temperaturabhängige Farbe  
Temperatura de color

**Finishing** — 1 — 5  
Finitura — White — Black  
Finitions — Bianco — Nero  
Oberflächenfinish — Blanc — Noir  
Acabados — Weiß — Schwarz  
Blanco — Negro

### Accessories

Accessori - Accessoires  
Zubehör - Accesorios

## ZQC001 ZQC001B

White — Black  
Bianco — Nero  
Blanc — Noir  
Weiß — Schwarz  
Blanco — Negro

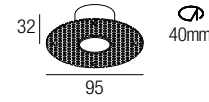

Plasterboard recessing frame  
Flangia per cartongesso  
Boîtier d'encastrement pour plaques de plâtre  
Gehäuses Trockenbau  
Cajetín para placas de yeso

## LL02 LL02B

White — Black  
Bianco — Nero  
Blanc — Noir  
Weiß — Schwarz  
Blanco — Negro

Low luminance louver  
Filtro antiabbagliamento  
Filtre basse luminance  
Geringe Leuchtdichte-Filter  
Filtro de baja luminancia



## SL02 SL02B

White — Black  
Bianco — Nero  
Blanc — Noir  
Weiß — Schwarz  
Blanco — Negro

Milky screen  
Schermo opale  
Écran opale  
Opal-Bildschirm  
Pantalla opal



## AL7022

24VDC/500mA constant current converter  
Convertitore 24VDC/500mA corrente costante  
Convertisseur 24VDC/500mA courant constant  
24VDC/500mA konstanter Strom konverter  
Convertidor 24VDC/500mA corriente constante

**Note:** versions with extended arm length are available upon request **Nota:** versioni con lunghezza del braccetto maggiorata disponibili su richiesta **Note:** versions avec longueur du bras majorée disponibles sur demande **Anmerkung:** versionen mit erhöhter Armlänge auf Anfrage erhältlich **Nota:** Versiones con longitud del brazo aumentada disponible bajo pedido

### Drivers

Alimentatori - Alimentateurs  
Netzteile - Alimentadores

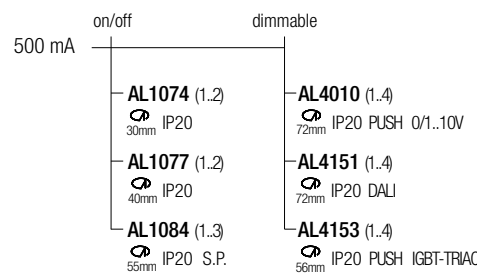

### Code Construction

Costruzione del codice - Construction du code produit  
Bau der Produkt-Code - Construcción del código de producto

## LADF1 X X X X

**Beam angle** — N — S — M  
Apertura di fascio — 10° — 25° — 40°  
Angle de faisceau  
Strahlwinkel  
Ángulo del haz

**CRI** — 8 — 9  
85 — 93

**Color Temperature** — 2 — 3 — 4  
Temperatura colore — 2700K — 3000K — 4000K  
Température couleur  
Temperaturabhängige Farbe  
Temperatura de color

**Finishing** — 1 — 5  
Finitura — White — Black  
Finitions — Bianco — Nero  
Oberflächenfinish — Blanc — Noir  
Acabados — Weiß — Schwarz  
Blanco — Negro

### Accessories

Accessori - Accessoires  
Zubehör - Accesorios

## ZQC001 ZQC001B

White — Black  
Bianco — Nero  
Blanc — Noir  
Weiß — Schwarz  
Blanco — Negro

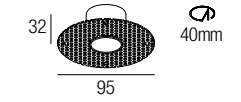

Plasterboard recessing frame  
Flangia per cartongesso  
Boîtier d'encastrement pour plaques de plâtre  
Gehäuses Trockenbau  
Cajetín para placas de yeso

## LL01 LL01B

White — Black  
Bianco — Nero  
Blanc — Noir  
Weiß — Schwarz  
Blanco — Negro

Low luminance louver  
Filtro antiabbagliamento  
Filtre basse luminance  
Geringe Leuchtdichte-Filter  
Filtro de baja luminancia



## SL01 SL01B

White — Black  
Bianco — Nero  
Blanc — Noir  
Weiß — Schwarz  
Blanco — Negro

Milky screen  
Schermo opale  
Écran opale  
Opal-Bildschirm  
Pantalla opal



## AL7022

24VDC/500mA constant current converter  
Convertitore 24VDC/500mA corrente costante  
Convertisseur 24VDC/500mA courant constant  
24VDC/500mA konstanter Strom konverter  
Convertidor 24VDC/500mA corriente constante

**Note:** versions with extended arm length are available upon request **Nota:** versioni con lunghezza del braccetto maggiorata disponibili su richiesta **Note:** versions avec longueur du bras majorée disponibles sur demande **Anmerkung:** versionen mit erhöhter Armlänge auf Anfrage erhältlich **Nota:** Versiones con longitud del brazo aumentada disponible bajo pedido

### Drivers

Alimentatori - Alimentateurs  
Netzteile - Alimentadores

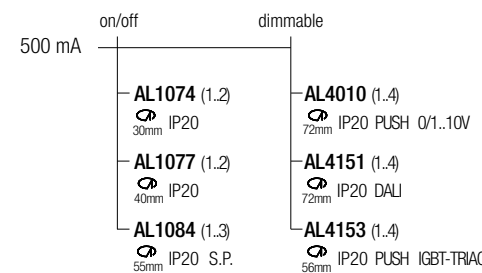

# LAD F10 WALL WASHER

design: Roberto Mantovani

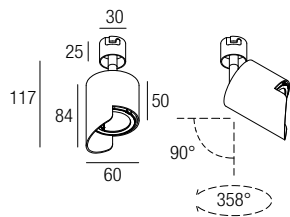

**Supply current**  
Alimentazione  
Courant d'alimentation  
Stromversorgung  
Corriente de alimentación  
**500 mA (V<sub>i</sub> 18V)**

**Power**  
Potenza  
Puissance  
Bestuekung  
Potencia  
**10 W**

**Series wiring**  
Cablaggio in serie  
Câblage en série  
Verkabelung in Serie  
Cableado en serie



**Photometric diagrams**

F984

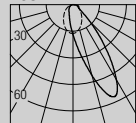

WALL WASHER

**CCT/CRI/Flux**

	CRI85	CRI93
2700K	890lm	840lm
3000K	1000lm	930lm
4000K	1040lm	960lm

**CRI85-93**  
**2-Step MacAdam**



# MINIJOS R2

design: Roberto Mantovani

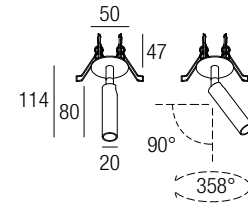

**Supply current**  
Alimentazione  
Courant d'alimentation  
Stromversorgung  
Corriente de alimentación  
**500 mA (V<sub>i</sub> 2,9V)**

**Power**  
Potenza  
Puissance  
Bestuekung  
Potencia  
**2 W**

**Series wiring**  
Cablaggio in serie  
Câblage en série  
Verkabelung in Serie  
Cableado en serie



**Photometric diagrams**

F701

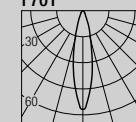

F702

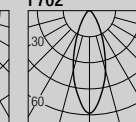

20°

40°

**CCT/CRI/Flux**

	128 lm
2700K	
3000K	133 lm
4200K	154 lm

**CRI85**  
**2-Step MacAdam**



**Code Construction**

Costruzione del codice - Construction du code produit  
Bau der Produkt-Code - Construcción del código de producto

**LADFW X X X**

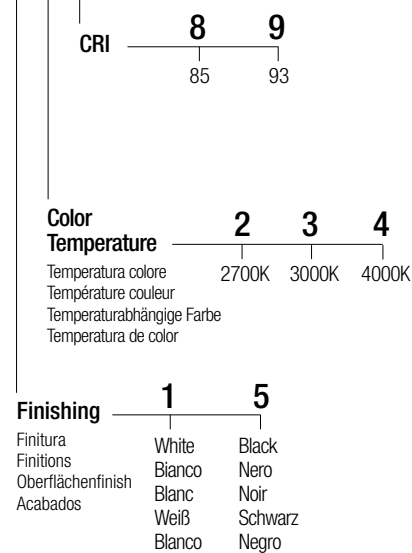

**Accessories**

Accessori - Accessoires  
Zubehör - Accesorios

**ZQC001 ZQC001B**

White Black  
Bianco Nero  
Blanc Noir  
Weiß Schwarz  
Blanco Negro

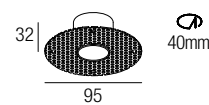

Plasterboard recessing frame  
Flangia per cartongesso  
Boîtier d'encastrement pour plaques de plâtre  
Gehäuse Trockenbau  
Cajetín para placas de yeso

**AL7022**

24VDC/500mA constant current converter  
Convertitore 24VDC/500mA corrente costante  
Convertisseur 24VDC/500mA courant constant  
24VDC/500mA konstanter Strom konverter  
Convertidor 24VDC/500mA corriente constante

**Note:** versions with extended arm length are available upon request **Nota:** versioni con lunghezza del braccetto maggiorata disponibili su richiesta **Note:** versions avec longueur du bras majorée disponibles sur demande **Anmerkung:** versionen mit erhöhter Armlänge auf Anfrage erhältlich **Nota:** Versiones con longitud del brazo aumentada disponible bajo pedido

**Code Construction**

Costruzione del codice - Construction du code produit  
Bau der Produkt-Code - Construcción del código de producto

**MJSR2 X X X**

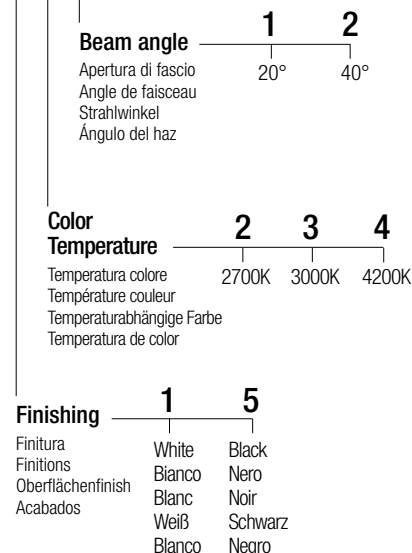

**Accessories**

Accessori - Accessoires  
Zubehör - Accesorios

**AL7022**

24VDC/500mA constant current converter  
Convertitore 24VDC/500mA corrente costante  
Convertisseur 24VDC/500mA courant constant  
24VDC/500mA konstanter Strom konverter  
Convertidor 24VDC/500mA corriente constante

**Note:** versions with extended arm length are available upon request **Nota:** versioni con lunghezza del braccetto maggiorata disponibili su richiesta **Note:** versions avec longueur du bras majorée disponibles sur demande **Anmerkung:** versionen mit erhöhter Armlänge auf Anfrage erhältlich **Nota:** Versiones con longitud del brazo aumentada disponible bajo pedido

**Drivers**

Alimentatori - Alimentateurs  
Netzteile - Alimentadores

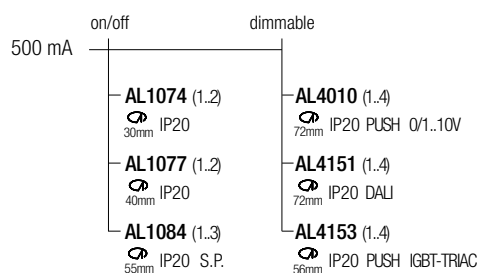

**Drivers**

Alimentatori - Alimentateurs  
Netzteile - Alimentadores

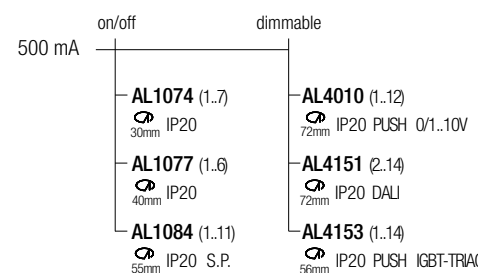



# MINIJOS R6

design: Roberto Mantovani

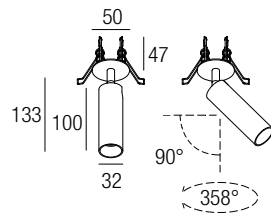
**Supply current**

Alimentazione  
Courant d'alimentation  
Stromversorgung  
Corriente de alimentación  
**500 mA (V<sub>i</sub> 9V)**

**Power**

Potenza  
Puissance  
Bestuekung  
Potencia  
**6 W**

**Series wiring**

Cablaggio in serie  
Câblage en série  
Verkabelung in Serie  
Cableado en serie

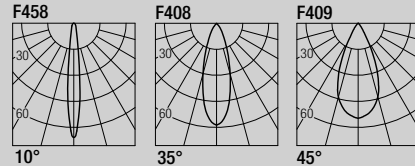
**Photometric diagrams****CCT/CRI/Flux**

2700K — 540 lm  
3000K — 600 lm  
4000K — 620 lm

**CRI98**  
2-Step MacAdam

**Code Construction**

Costruzione del codice - Construction du code produit  
Bau der Produkt-Code - Construcción del código de producto

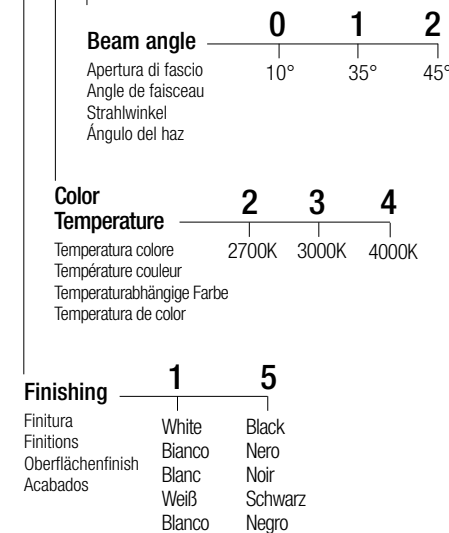
**MJSR6 X X X****Drivers**

Alimentatori - Alimentateurs  
Netzteile - Alimentadores

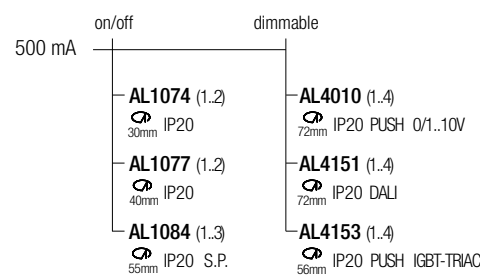

# MINIJOS R10

design: Roberto Mantovani

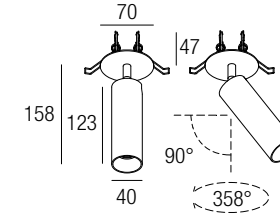
**Supply current**

Alimentazione  
Courant d'alimentation  
Stromversorgung  
Corriente de alimentación  
**500 mA (V<sub>i</sub> 18V)**

**Power**

Potenza  
Puissance  
Bestuekung  
Potencia  
**10 W**

**Series wiring**

Cablaggio in serie  
Câblage en série  
Verkabelung in Serie  
Cableado en serie

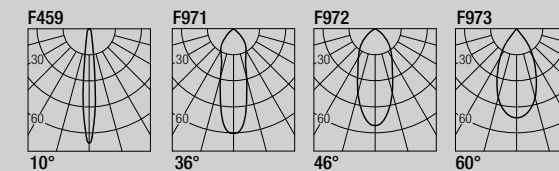
**Photometric diagrams****CCT/CRI/Flux**

CRI85 CRI93  
2700K — 890lm 840lm  
3000K — 1000lm 930lm  
4000K — 1040lm 960lm

**CRI85-93**  
2-Step MacAdam

**Code Construction**

Costruzione del codice - Construction du code produit  
Bau der Produkt-Code - Construcción del código de producto

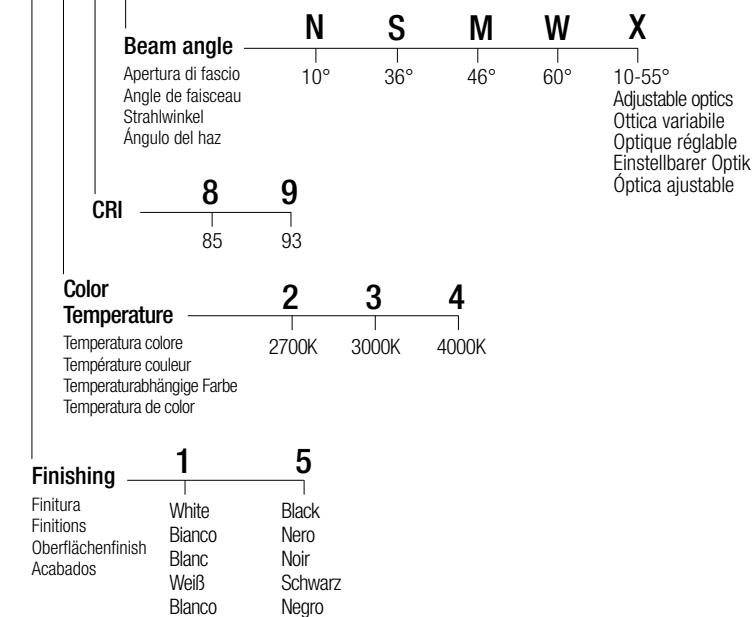
**MJSR1 X X X X****Drivers**

Alimentatori - Alimentateurs  
Netzteile - Alimentadores

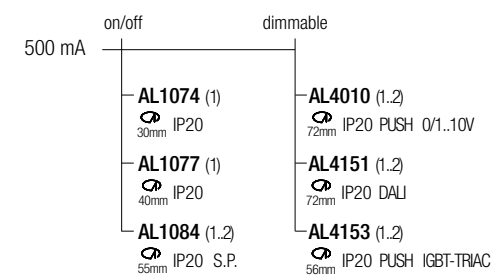
**Accessories**

Accessori - Accessoires  
Zubehör - Accesorios

<b>LJ02</b> White Bianco Blanc Weiß Blanco	<b>LJ02B</b> Black Nero Noir Schwarz Negro	<b>SJ02</b> White Bianco Blanc Weiß Blanco	<b>SJ02B</b> Black Nero Noir Schwarz Negro
---	---	---	---

Low luminance louver  
Filtro antiabbagliamento  
Filtre basse luminance  
Geringe Leuchtdichte-Filter  
Filtro de baja luminancia

Milky screen  
Schermo opale  
Écran opale  
Opal-Bildschirm  
Pantalla opal

**AL7022**

24VDC/500mA constant current converter  
Convertitore 24VDC/500mA corrente costante  
Convertisseur 24VDC/500mA courant constant  
24VDC/500mA konstanter Strom konverter  
Convertidor 24VDC/500mA corriente constante

**Note:** versions with extended arm length are available upon request **Nota:** versioni con lunghezza del braccetto maggiorata disponibili su richiesta **Note:** versions avec longueur du bras majorée disponibles sur demande **Anmerkung:** versionen mit erhöhter Armlänge auf Anfrage erhältlich **Nota:** Versiones con longitud del brazo aumentada disponible bajo pedido

**Accessories**

Accessori - Accessoires  
Zubehör - Accesorios

<b>LJ01</b> White Bianco Blanc Weiß Blanco	<b>LJ01B</b> Black Nero Noir Schwarz Negro	<b>SJ01</b> White Bianco Blanc Weiß Blanco	<b>SJ01B</b> Black Nero Noir Schwarz Negro
---	---	---	---

Low luminance louver  
Filtro antiabbagliamento  
Filtre basse luminance  
Geringe Leuchtdichte-Filter  
Filtro de baja luminancia

Milky screen  
Schermo opale  
Écran opale  
Opal-Bildschirm  
Pantalla opal

**AL7022**

24VDC/500mA constant current converter  
Convertitore 24VDC/500mA corrente costante  
Convertisseur 24VDC/500mA courant constant  
24VDC/500mA konstanter Strom konverter  
Convertidor 24VDC/500mA corriente constante

**Note:** versions with extended arm length are available upon request **Nota:** versioni con lunghezza del braccetto maggiorata disponibili su richiesta **Note:** versions avec longueur du bras majorée disponibles sur demande **Anmerkung:** versionen mit erhöhter Armlänge auf Anfrage erhältlich **Nota:** Versiones con longitud del brazo aumentada disponible bajo pedido

# MINIJOS S2

design: Roberto Mantovani

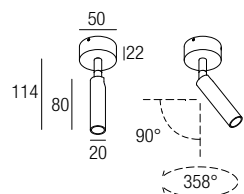

### Supply current

Alimentazione  
Courant d'alimentation  
Stromversorgung  
Corriente de alimentación

24 VDC

### Power

Potenza  
Puissance  
Bestuekung  
Potencia

2 W

### Series wiring

Cablaggio in serie  
Câblage en série  
Verkabelung in Serie  
Cableado en serie



### CCT/CRI/Flux

### Photometric diagrams

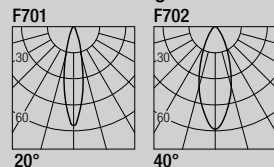

2700K — 128 lm  
3000K — 133 lm  
4200K — 154 lm

### CRI85

2-Step MacAdam



### Code Construction

Costruzione del codice - Construction du code produit  
Bau der Produkt-Code - Construcción del código de producto

## MJSS2 X X X

**Beam angle** — 1 — 2  
Apertura di fascio — 20° — 40°  
Angle de faisceau  
Strahlwinkel  
Ángulo del haz

**Color Temperature** — 2 — 3 — 4  
Temperatura colore — 2700K — 3000K — 4200K  
Température couleur  
Temperaturabhängige Farbe  
Temperatura de color

**Finishing** — 1 — 5  
Finitura — White — Black  
Finitions — Bianco — Nero  
Oberflächenfinish — Blanc — Noir  
Acabados — Weiß — Schwarz  
Blanco — Negro

### Drivers

Alimentatori - Alimentateurs  
Netzteile - Alimentadores

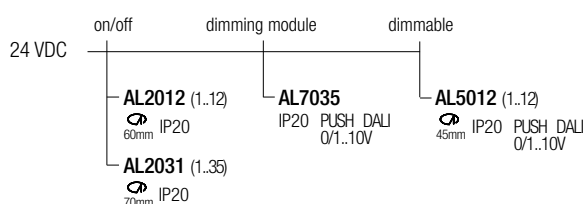

**Note:** dimming module AL7035 to be used in combination with an on/off 24VDC power supply **Note:** modulo di dimmerazione AL7035 da utilizzare in combinazione con un alimentatore on/off 24VDC **Note:** module de variation AL7035 d'intensité à utiliser en combinaison avec une alimentation on/off 24VDC **Anmerkung:** Dimmmodul AL7035 zur Verwendung in Kombination mit einem on/off 24VDC-Netzteil **Note:** módulo de regulación AL7035 se utiliza en combinación con una fuente de alimentación on/off 24VDC

# MINIJOS S6

design: Roberto Mantovani

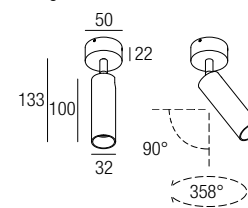

### Supply current

Alimentazione  
Courant d'alimentation  
Stromversorgung  
Corriente de alimentación

24 VDC

### Power

Potenza  
Puissance  
Bestuekung  
Potencia

6 W

### Series wiring

Cablaggio in serie  
Câblage en série  
Verkabelung in Serie  
Cableado en serie



### CCT/CRI/Flux

### Photometric diagrams

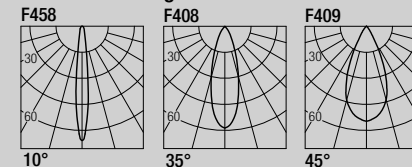

2700K — 540 lm  
3000K — 600 lm  
4000K — 620 lm

### CRI98

2-Step MacAdam



### Code Construction

Costruzione del codice - Construction du code produit  
Bau der Produkt-Code - Construcción del código de producto

## MJSS6 X X X

**Beam angle** — 0 — 1 — 2  
Apertura di fascio — 10° — 35° — 45°  
Angle de faisceau  
Strahlwinkel  
Ángulo del haz

**Color Temperature** — 2 — 3 — 4  
Temperatura colore — 2700K — 3000K — 4000K  
Température couleur  
Temperaturabhängige Farbe  
Temperatura de color

**Finishing** — 1 — 5  
Finitura — White — Black  
Finitions — Bianco — Nero  
Oberflächenfinish — Blanc — Noir  
Acabados — Weiß — Schwarz  
Blanco — Negro

### Drivers

Alimentatori - Alimentateurs  
Netzteile - Alimentadores

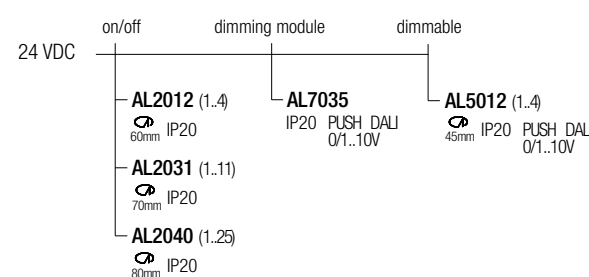

**Note:** dimming module AL7035 to be used in combination with an on/off 24VDC power supply **Note:** modulo di dimmerazione AL7035 da utilizzare in combinazione con un alimentatore on/off 24VDC **Note:** module de variation AL7035 d'intensité à utiliser en combinaison avec une alimentation on/off 24VDC **Anmerkung:** Dimmmodul AL7035 zur Verwendung in Kombination mit einem on/off 24VDC-Netzteil **Note:** módulo de regulación AL7035 se utiliza en combinación con una fuente de alimentación on/off 24VDC

### Accessories

Accessori - Accessoires  
Zubehör - Accesorios

LJ02	LJ02B	SJ02	SJ02B
White	Black	White	Black
Bianco	Nero	Bianco	Nero
Blanc	Noir	Blanc	Noir
Weiß	Schwarz	Weiß	Schwarz
Blanco	Negro	Blanco	Negro

Low luminance louver  
Filtro antiabbagliamento  
Filtre basse luminance  
Geringe Leuchtdichte-Filter  
Filtro de baja luminancia



Milky screen  
Schermo opale  
Écran opale  
Opal-Bildschirm  
Pantalla opal



**Note:** versions with extended arm length are available upon request **Note:** versioni con lunghezza del braccetto maggiorata disponibili su richiesta **Note:** versions avec longueur du bras majorée disponibles sur demande **Anmerkung:** versionen mit erhöhter Armlänge auf Anfrage erhältlich **Note:** Versiones con longitud del brazo aumentada disponible bajo pedido

# MINIJOS S10

design: Roberto Mantovani

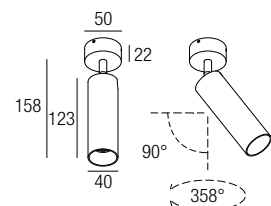

### Supply current

Alimentazione  
Courant d'alimentation  
Stromversorgung  
Corriente de alimentación

24 VDC

### Power

Potenza  
Puissance  
Bestuekung  
Potencia

10 W

### Series wiring

Cablaggio in serie  
Câblage en série  
Verkabelung in Serie  
Cableado en serie



### Photometric diagrams

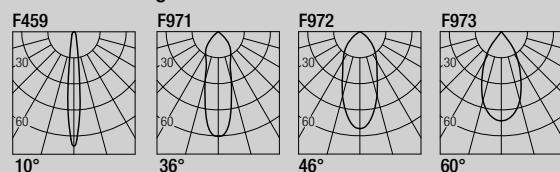

### CCT/CRI/Flux

	CRI85	CRI93
2700K	890lm	840lm
3000K	1000lm	930lm
4000K	1040lm	960lm

### CRI85-93

2-Step MacAdam



### Code Construction

Costruzione del codice - Construction du code produit  
Bau der Produkt-Code - Construcción del código de producto

### MJSS1 X X X X

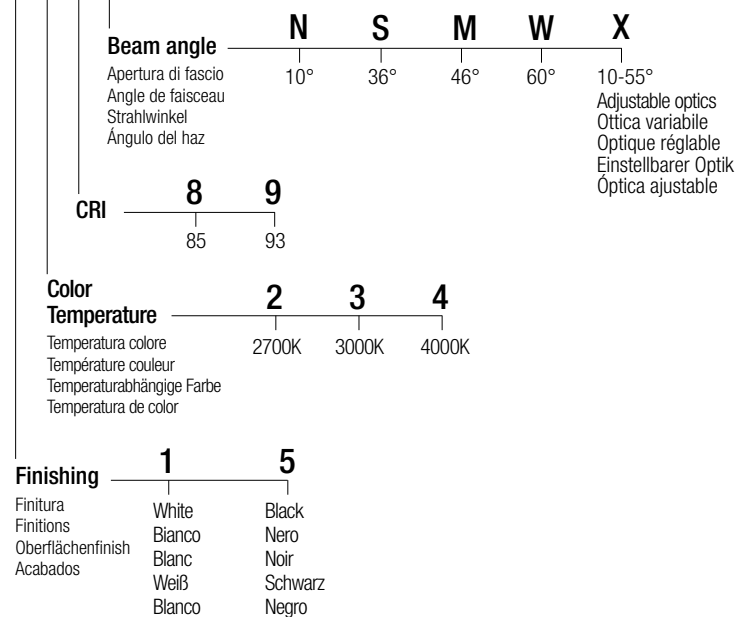

### Accessories

Accessori - Accessoires  
Zubehör - Accesorios

LJ01	LJ01B	SJ01	SJ01B
White Bianco Blanc Weiß Blanco	Black Nero Noir Schwarz Negro	White Bianco Blanc Weiß Blanco	Black Nero Noir Schwarz Negro
Low luminance louver Filtro antiabbagliamento Filtre basse luminance Geringe Leuchtdichte-Filter Filtro de baja luminancia		Milky screen Schermo opale Écran opale Opal-Bildschirm Pantalla opal	

**Note:** versions with extended arm length are available upon request **Nota:** versioni con lunghezza del braccetto maggiorata disponibili su richiesta **Note:** versions avec longueur du bras majorée disponibles sur demande **Anmerkung:** versionen mit erhöhter Armlänge auf Anfrage erhältlich **Nota:** Versiones con longitud del brazo aumentada disponible bajo pedido

### Drivers

Alimentatori - Alimentateurs  
Netzteile - Alimentadores

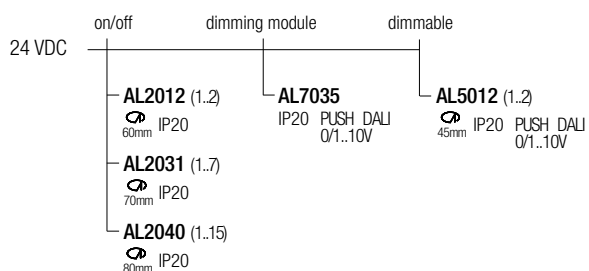

**Note:** dimming module AL7035 to be used in combination with an on/off 24VDC power supply **Nota:** modulo di dimmerazione AL7035 da utilizzare in combinazione con un alimentatore on/off 24VDC **Note:** module de variation AL7035 d'intensité à utiliser en combinaison avec une alimentation on/off 24VDC **Anmerkung:** Dimmmodul AL7035 zur Verwendung in Kombination mit einem on/off 24VDC-Netzteil **Nota:** módulo de regulación AL7035 se utiliza en combinación con una fuente de alimentación on/off 24VDC

# JOS T2

design: Roberto Mantovani

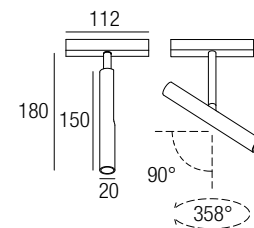

### Supply current

Alimentazione  
Courant d'alimentation  
Stromversorgung  
Corriente de alimentación

24 VDC

### Power

Potenza  
Puissance  
Bestuekung  
Potencia

2 W



### Photometric diagrams

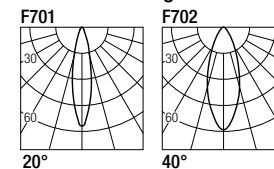

### CCT/CRI/Flux

2700K	128 lm
3000K	133 lm
4200K	154 lm

### CRI85

2-Step MacAdam



### Code Construction

Costruzione del codice - Construction du code produit  
Bau der Produkt-Code - Construcción del código de producto

### JST2 X X X

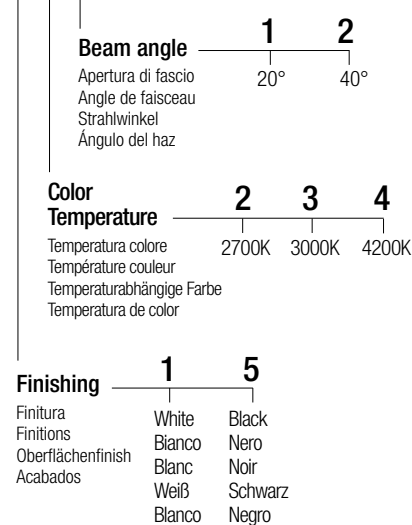

**Note:** versions with extended arm length are available upon request **Nota:** versioni con lunghezza del braccetto maggiorata disponibili su richiesta **Note:** versions avec longueur du bras majorée disponibles sur demande **Anmerkung:** versionen mit erhöhter Armlänge auf Anfrage erhältlich **Nota:** Versiones con longitud del brazo aumentada disponible bajo pedido

# JOS T6

design: Roberto Mantovani

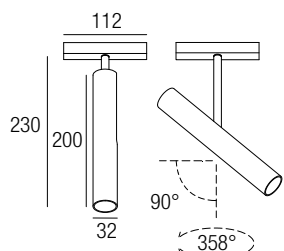

## Supply current

Alimentazione  
Courant d'alimentation  
Stromversorgung  
Corriente de alimentación

24 VDC

## Power

Potenza  
Puissance  
Bestuekung  
Potencia

6 W



## Photometric diagrams

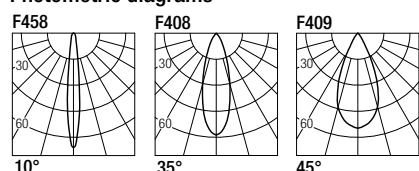

## CCT/CRI/Flux

2700K — 540 lm  
3000K — 600 lm  
4000K — 620 lm

## CRI98

2-Step MacAdam

## Code Construction

Costruzione del codice - Construction du code produit  
Bau der Produkt-Code - Construcción del código de producto

## JST6 X X X

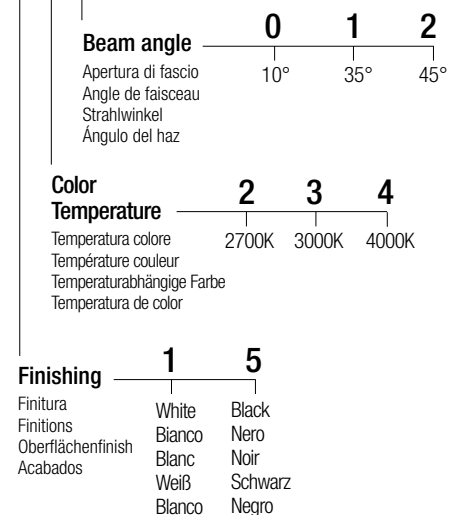

**Note:** versions with extended arm length are available upon request **Nota:** versioni con lunghezza del braccetto maggiorata disponibili su richiesta **Note:** versions avec longueur du bras majorée disponibles sur demande **Anmerkung:** versionen mit erhöhter Armlänge auf Anfrage erhältlich **Nota:** Versiones con longitud del brazo aumentada disponible bajo pedido

[DATASHEET](#) [INSTALLATION MANUAL](#)
[CERTIFICATIONS](#) [LDT-IES](#) [DRAWINGS](#)



## Accessories

Accessori - Accessoires  
Zubehör - Accesorios

<b>LJ02</b> White Bianco Blanc Weiß Blanco	<b>LJ02B</b> Black Nero Noir Schwarz Negro	<b>SJ02</b> White Bianco Blanc Weiß Blanco	<b>SJ02B</b> Black Nero Noir Schwarz Negro
Low luminance louver Filtro antiabbagliamento Filtre basse luminance Geringe Leuchtdichte-Filter Filtro de baja luminancia		Milky screen Schermo opale Écran opale Opal-Bildschirm Pantalla opal	

# JOS T10

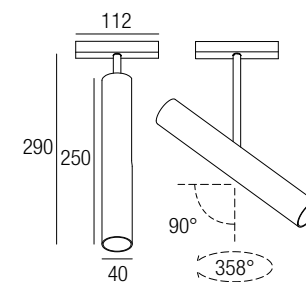
design: Roberto Mantovani



## Supply current

Alimentazione  
Courant d'alimentation  
Stromversorgung  
Corriente de alimentación

24 VDC

## Power

Potenza  
Puissance  
Bestuekung  
Potencia

10 W



## Photometric diagrams

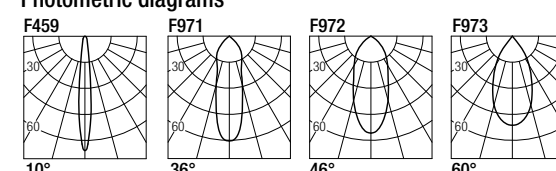

## CCT/CRI/Flux

CRI85 CRI93  
2700K — 890 lm 840 lm  
3000K — 1000 lm 930 lm  
4000K — 1040 lm 960 lm

## CRI85 - CRI93

2-Step MacAdam

## Code Construction

Costruzione del codice - Construction du code produit  
Bau der Produkt-Code - Construcción del código de producto

## JST1 X X X X

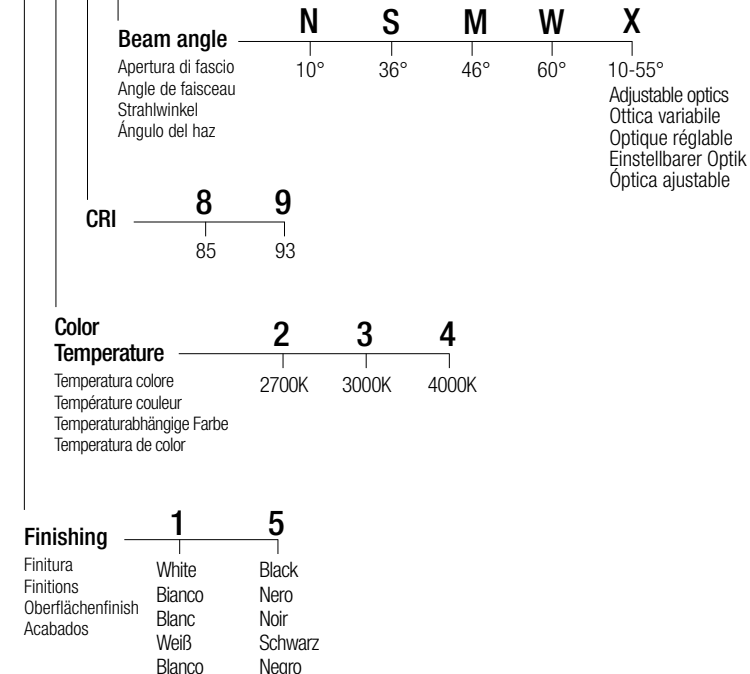

**Note:** versions with extended arm length are available upon request **Nota:** versioni con lunghezza del braccetto maggiorata disponibili su richiesta **Note:** versions avec longueur du bras majorée disponibles sur demande **Anmerkung:** versionen mit erhöhter Armlänge auf Anfrage erhältlich **Nota:** Versiones con longitud del brazo aumentada disponible bajo pedido

[DATASHEET](#) [INSTALLATION MANUAL](#)
[CERTIFICATIONS](#) [LDT-IES](#) [DRAWINGS](#)

## Accessories

Accessori - Accessoires  
Zubehör - Accesorios

<b>LJ01</b> White Bianco Blanc Weiß Blanco	<b>LJ01B</b> Black Nero Noir Schwarz Negro	<b>SJ01</b> White Bianco Blanc Weiß Blanco	<b>SJ01B</b> Black Nero Noir Schwarz Negro
Low luminance louver Filtro antiabbagliamento Filtre basse luminance Geringe Leuchtdichte-Filter Filtro de baja luminancia		Milky screen Schermo opale Écran opale Opal-Bildschirm Pantalla opal	

**Note:** the filter and the screen are not available in adjustable optics version 10-55° - **Nota:** il filtro e lo schermo non sono disponibili nella versione ad ottica regolabile 10-55° - **Note:** le filtre et l'écran ne sont pas disponibles dans la version à optique réglable 10-55° - **Anmerkung:** Filter und Bildschirm sind in der einstellbaren optischen Version 10-55° nicht verfügbar - **Nota:** el filtro y la pantalla no están disponibles en la versión de óptica ajustable 10-55°



# JOS T2P

design: Roberto Mantovani

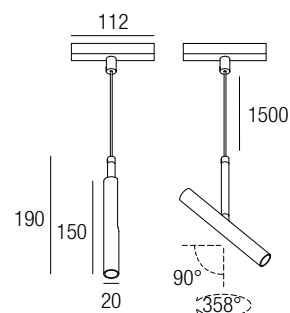

**Supply current**  
Alimentazione  
Courant d'alimentation  
Stromversorgung  
Corriente de alimentación  
**24 VDC**

**Power**  
Potenza  
Pouissance  
Bestuekung  
Potencia  
**2 W**



**CCT/CRI/Flux**

2700K — 128 lm  
3000K — 133 lm  
4200K — 154 lm

**CRI85**  
2-Step MacAdam

**Photometric diagrams**

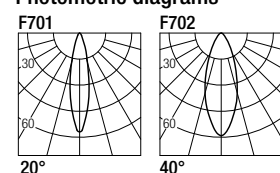

**Code Construction**

Costruzione del codice - Construction du code produit  
Bau der Produkt-Code - Construcción del código de producto

**JST2P X X X**

<b>Beam angle</b>	1	2	
Apertura di fascio	20°	40°	
Angle de faisceau			
Strahlwinkel			
Ángulo del haz			
<b>Color Temperature</b>	2	3	4
Temperatura colore	2700K	3000K	4200K
Température couleur			
Temperaturabhängige Farbe			
Temperatura de color			
<b>Finishing</b>	1	5	
Finitura	White	Black	
Finitions	Bianco	Nero	
Oberflächenfinish	Blanc	Noir	
Acabados	Weiß	Schwarz	
	Blanco	Negro	

**Note:** cable cut to measure on request  
**Nota:** cavo a misura disponibile su richiesta  
**Note:** câble sur mesure disponible sur demande  
**Anmerkung:** kundenspezifisches Kabel auf Anfrage erhältlich  
**Nota:** cable a medida disponible a petición



# JOS T6P

design: Roberto Mantovani

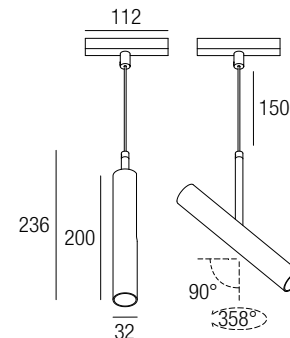

**Supply current**  
Alimentazione  
Courant d'alimentation  
Stromversorgung  
Corriente de alimentación  
**24 VDC**

**Power**  
Potenza  
Pouissance  
Bestuekung  
Potencia  
**6 W**



**CCT/CRI/Flux**

2700K — 540 lm  
3000K — 600 lm  
4000K — 620 lm

**CRI98**  
2-Step MacAdam

**Photometric diagrams**

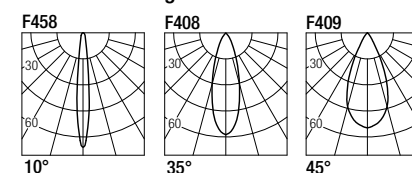

**Code Construction**

Costruzione del codice - Construction du code produit  
Bau der Produkt-Code - Construcción del código de producto

**JST6P X X X**

<b>Beam angle</b>	0	1	2
Apertura di fascio	10°	35°	45°
Angle de faisceau			
Strahlwinkel			
Ángulo del haz			
<b>Color Temperature</b>	2	3	4
Temperatura colore	2700K	3000K	4000K
Température couleur			
Temperaturabhängige Farbe			
Temperatura de color			
<b>Finishing</b>	1	5	
Finitura	White	Black	
Finitions	Bianco	Nero	
Oberflächenfinish	Blanc	Noir	
Acabados	Weiß	Schwarz	
	Blanco	Negro	

**Note:** cable cut to measure on request  
**Nota:** cavo a misura disponibile su richiesta  
**Note:** câble sur mesure disponible sur demande  
**Anmerkung:** kundenspezifisches Kabel auf Anfrage erhältlich  
**Nota:** cable a medida disponible a petición



**Accessories**

Accessori - Accessoires  
Zubehör - Accesorios

<b>LJ02</b> White Bianco Blanc Weiß Blanco	<b>LJ02B</b> Black Nero Noir Schwarz Negro	<b>SJ02</b> White Bianco Blanc Weiß Blanco	<b>SJ02B</b> Black Nero Noir Schwarz Negro
Low luminance louver Filtro antiabbagliamento Filtre basse luminance Geringe Leuchtdichte-Filter Filtro de baja luminancia		Milky screen Schermo opale Écran opale Opal-Bildschirm Pantalla opal	

# JOS T10P

design: Roberto Mantovani

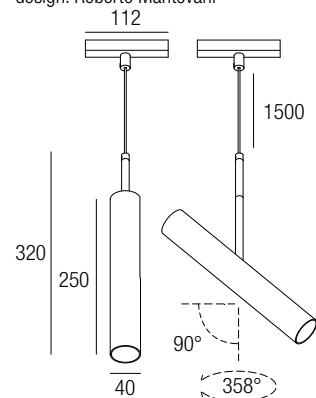

**Supply current**  
Alimentazione  
Courant d'alimentation  
Stromversorgung  
Corriente de alimentación  
**24 VDC**

**Power**  
Potenza  
Puissance  
Bestuekung  
Potencia  
**10 W**



### Photometric diagrams

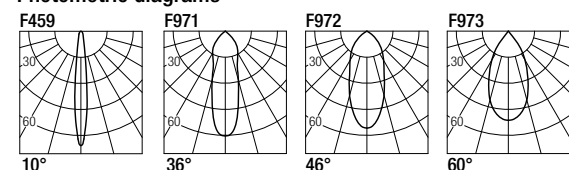

CCT/CRI/Flux	CRI85	CRI93
2700K	890 lm	840 lm
3000K	1000 lm	930 lm
4000K	1040 lm	960 lm

**CRI85 - CRI93**  
**2-Step MacAdam**

### Code Construction

Costruzione del codice - Construction du code produit  
Bau der Produkt-Code - Construcción del código de producto

## JST1P X X X X

<b>Beam angle</b> Apertura di fascio Angle de faisceau Strahlwinkel Ángulo del haz	<b>N</b> 10°	<b>S</b> 36°	<b>M</b> 46°	<b>W</b> 60°	<b>X</b> 10-55° Adjustable optics Optica variabile Optique réglable Einstellbarer Optik Óptica ajustable
<b>CRI</b>	<b>8</b> 85	<b>9</b> 93			
<b>Color Temperature</b> Temperatura colore Température couleur Temperaturabhängige Farbe Temperatura de color	<b>2</b> 2700K	<b>3</b> 3000K	<b>4</b> 4000K		
<b>Finishing</b> Finitura Finitions Oberflächenfinish Acabados	<b>1</b> White Bianco Blanc Weiß Blanco	<b>5</b> Black Nero Noir Schwarz Negro			

**Note:** cable cut to measure on request  
**Nota:** cavo a misura disponibile su richiesta  
**Note:** câble sur mesure disponible sur demande  
**Anmerkung:** kundenspezifisches Kabel auf Anfrage erhältlich  
**Nota:** cable a medida disponible a petición

- DATASHEET ▶
- INSTALLATION MANUAL ▶
- CERTIFICATIONS ▶
- LDT-IES ▶
- DRAWINGS ▶



### Accessories

Accessori - Accessoires  
Zubehör - Accesorios

<b>LJ01</b> White Bianco Blanc Weiß Blanco	<b>LJ01B</b> Black Nero Noir Schwarz Negro	<b>SJ01</b> White Bianco Blanc Weiß Blanco	<b>SJ01B</b> Black Nero Noir Schwarz Negro
Low luminance louver Filtro antiabbagliamento Filtre basse luminance Geringe Leuchtdichte-Filter Filtro de baja luminancia		Milky screen Schermo opale Écran opale Opal-Bildschirm Pantalla opal	

**Note:** the filter and the screen are not available in adjustable optics version 10-55° - **Nota:** il filtro e lo schermo non sono disponibili nella versione ad ottica regolabile 10-55° - **Note:** le filtre et l'écran ne sont pas disponibles dans la version à optique réglable 10-55° - **Anmerkung:** Filter und Bildschirm sind in der einstellbaren optischen Version 10-55° nicht verfügbar - **Nota:** el filtro y la pantalla no están disponibles en la versión de óptica ajustable 10-55°

# GAGARIN T2

design: Roberto Mantovani

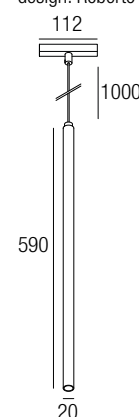

**Supply current**  
Alimentazione  
Courant d'alimentation  
Stromversorgung  
Corriente de alimentación  
**24 VDC**

**Power**  
Potenza  
Puissance  
Bestuekung  
Potencia  
**2 W**



### Photometric diagrams

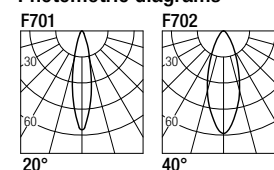

CCT/CRI/Flux	CRI85
2700K	128 lm
3000K	133 lm
4200K	154 lm

**CRI85**  
**2-Step MacAdam**

### Code Construction

Costruzione del codice - Construction du code produit  
Bau der Produkt-Code - Construcción del código de producto

## GT2 X X X

<b>Beam angle</b> Apertura di fascio Angle de faisceau Strahlwinkel Ángulo del haz	<b>1</b> 20°	<b>2</b> 40°	
<b>Color Temperature</b> Temperatura colore Température couleur Temperaturabhängige Farbe Temperatura de color	<b>2</b> 2700K	<b>3</b> 3000K	<b>4</b> 4200K
<b>Finishing</b> Finitura Finitions Oberflächenfinish Acabados	<b>1</b> White Bianco Blanc Weiß Blanco	<b>5</b> Black Nero Noir Schwarz Negro	

**Note:** cable cut to measure on request  
**Nota:** cavo a misura disponibile su richiesta  
**Note:** câble sur mesure disponible sur demande  
**Anmerkung:** kundenspezifisches Kabel auf Anfrage erhältlich  
**Nota:** cable a medida disponible a petición

- DATASHEET ▶
- INSTALLATION MANUAL ▶
- CERTIFICATIONS ▶
- LDT-IES ▶
- DRAWINGS ▶



# GAGARIN T6

design: Roberto Mantovani

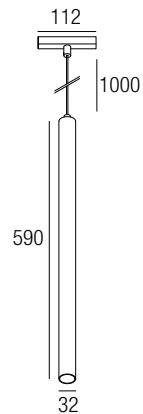

### Supply current

Alimentazione  
Courant d'alimentation  
Stromversorgung  
Corriente de alimentación

**24 VDC**

### Power

Potenza  
Puissance  
Bestuekung  
Potencia

**6 W**



### Photometric diagrams

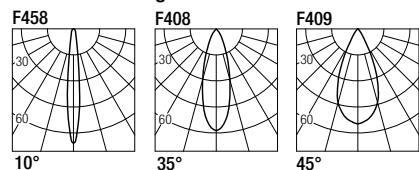

### CCT/CRI/Flux

2700K — 540 lm  
3000K — 600 lm  
4000K — 620 lm

**CRI98**  
**2-Step MacAdam**

### Code Construction

Costruzione del codice - Construction du code produit  
Bau der Produkt-Code - Construcción del código de producto

### GT6 X X X

**Beam angle** 0 1 2  
Apertura di fascio 10° 35° 45°  
Angle de faisceau  
Strahlwinkel  
Ángulo del haz

**Color Temperature** 2 3 4  
Temperatura colore 2700K 3000K 4000K  
Température couleur  
Temperaturabhängige Farbe  
Temperatura de color

**Finishing** 1 5  
Finitura White Black  
Finitions Bianco Nero  
Oberflächenfinish Blanc Noir  
Acabados Weiß Schwarz  
Blanco Negro

**Note:** cable cut to measure on request  
**Nota:** cavo a misura disponibile su richiesta  
**Note:** câble sur mesure disponible sur demande  
**Anmerkung:** kundenspezifisches Kabel auf Anfrage erhältlich  
**Nota:** cable a medida disponible a petición

[DATASHEET](#) [INSTALLATION MANUAL](#)

[CERTIFICATIONS](#) [LDT-IES](#) [DRAWINGS](#)



# GAGARIN T10

design: Roberto Mantovani

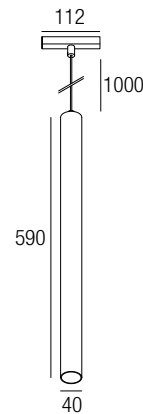

### Supply current

Alimentazione  
Courant d'alimentation  
Stromversorgung  
Corriente de alimentación

**24 VDC**

### Power

Potenza  
Puissance  
Bestuekung  
Potencia

**10 W**



### Photometric diagrams

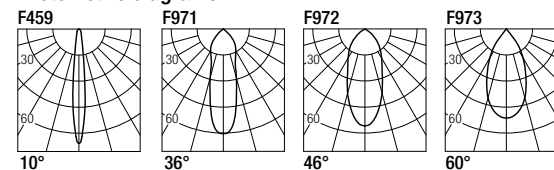

### CCT/CRI/Flux

CRI85 CRI93  
2700K — 890 lm 840 lm  
3000K — 1000 lm 930 lm  
4000K — 1040 lm 960 lm

**CRI85 - CRI93**  
**2-Step MacAdam**

### Code Construction

Costruzione del codice - Construction du code produit  
Bau der Produkt-Code - Construcción del código de producto

### GT1 X X X X

**Beam angle** N S M W X  
Apertura di fascio 10° 36° 46° 60° 10-55°  
Angle de faisceau  
Strahlwinkel  
Ángulo del haz  
Adjustable optics  
Optica variabile  
Optique réglable  
Einstellbarer Optik  
Óptica ajustable

**CRI** 8 9  
85 93

**Color Temperature** 2 3 4  
Temperatura colore 2700K 3000K 4000K  
Température couleur  
Temperaturabhängige Farbe  
Temperatura de color

**Finishing** 1 5  
Finitura White Black  
Finitions Bianco Nero  
Oberflächenfinish Blanc Noir  
Acabados Weiß Schwarz  
Blanco Negro

**Note:** cable cut to measure on request  
**Nota:** cavo a misura disponibile su richiesta  
**Note:** câble sur mesure disponible sur demande  
**Anmerkung:** kundenspezifisches Kabel auf Anfrage erhältlich  
**Nota:** cable a medida disponible a petición

[DATASHEET](#) [INSTALLATION MANUAL](#)

[CERTIFICATIONS](#) [LDT-IES](#) [DRAWINGS](#)



### Accessories

Accessori - Accessoires  
Zubehör - Accesorios

<b>LJ02</b> White Bianco Blanc Weiß Blanco	<b>LJ02B</b> Black Nero Noir Schwarz Negro	<b>SJ02</b> White Bianco Blanc Weiß Blanco	<b>SJ02B</b> Black Nero Noir Schwarz Negro
Low luminance louver Filtro antiabbagliamento Filtre basse luminance Geringe Leuchtdichte-Filter Filtro de baja luminancia		Milky screen Schermo opale Écran opale Opal-Bildschirm Pantalla opal	

### Accessories

Accessori - Accessoires  
Zubehör - Accesorios

<b>LJ01</b> White Bianco Blanc Weiß Blanco	<b>LJ01B</b> Black Nero Noir Schwarz Negro	<b>SJ01</b> White Bianco Blanc Weiß Blanco	<b>SJ01B</b> Black Nero Noir Schwarz Negro
Low luminance louver Filtro antiabbagliamento Filtre basse luminance Geringe Leuchtdichte-Filter Filtro de baja luminancia		Milky screen Schermo opale Écran opale Opal-Bildschirm Pantalla opal	

**Note:** the filter and the screen are not available in adjustable optics version 10-55° - **Nota:** il filtro e lo schermo non sono disponibili nella versione ad ottica regolabile 10-55° - **Note:** le filtre et l'écran ne sont pas disponibles dans la version à optique réglable 10-55° - **Anmerkung:** Filter und Bildschirm sind in der einstellbaren optischen Version 10-55° nicht verfügbar - **Nota:** el filtro y la pantalla no están disponibles en la versión de óptica ajustable 10-55°

# ELF 2

design: Roberto Mantovani

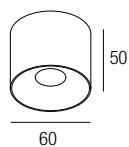

### Supply current

Alimentazione  
Courant d'alimentation  
Stromversorgung  
Corriente de alimentación

**350-500 mA (V, 2,9V)**

### Power

Potenza  
Puissance  
Bestuekung  
Potencia

**1-2 W**

### Series wiring

Cablaggio in serie  
Câblage en série  
Verkabelung in Serie  
Cableado en serie



### Photometric diagrams

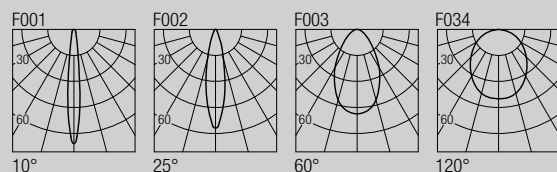

### CCT/CRI/Flux

CCT	350mA	500mA
2700K	89lm	128lm
3000K	93lm	133lm
4200K	103lm	154lm
6000K	114lm	165lm

### CRI85

2-Step MacAdam



### Code Construction

Costruzione del codice - Construction du code produit  
Bau der Produkt-Code - Construcción del código de producto

### EF2 X, X, X

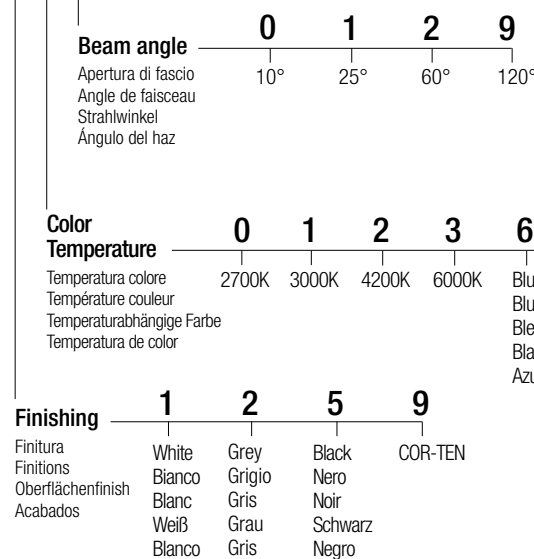

### Drivers

Alimentatori - Alimentateurs  
Netzteile - Alimentadores

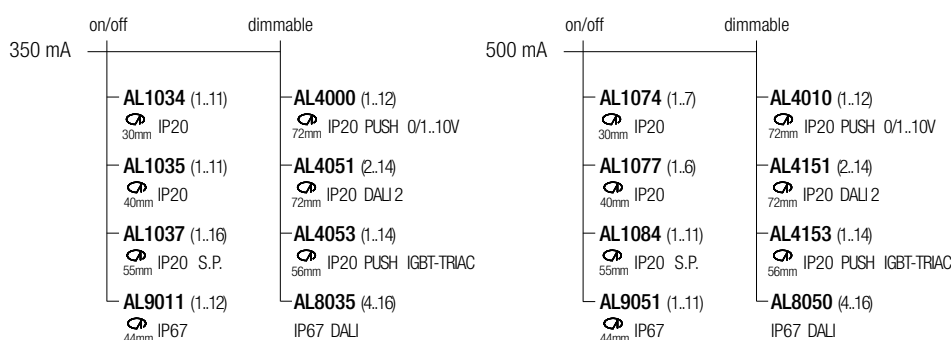

# ELF 6

design: Roberto Mantovani

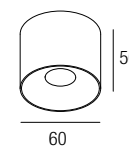

### Supply current

Alimentazione  
Courant d'alimentation  
Stromversorgung  
Corriente de alimentación

**350-500 mA (V, 8,7V)**

### Power

Potenza  
Puissance  
Bestuekung  
Potencia

**3-6 W**

### Series wiring

Cablaggio in serie  
Câblage en série  
Verkabelung in Serie  
Cableado en serie



### Photometric diagrams

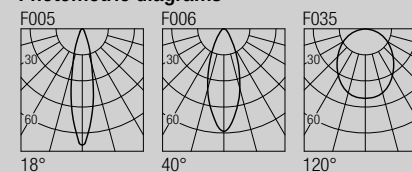

### CCT/CRI/Flux

CCT	350mA	500mA
2700K	267lm	384lm
3000K	279lm	400lm
4200K	309lm	462lm
6000K	342lm	495lm

### CRI98

2-Step MacAdam



### Code Construction

Costruzione del codice - Construction du code produit  
Bau der Produkt-Code - Construcción del código de producto

### EF6 X, X, X

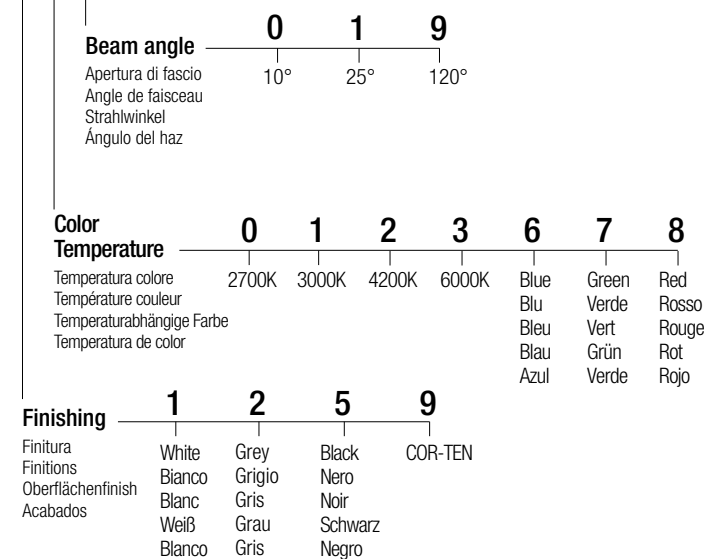

### Drivers

Alimentatori - Alimentateurs  
Netzteile - Alimentadores

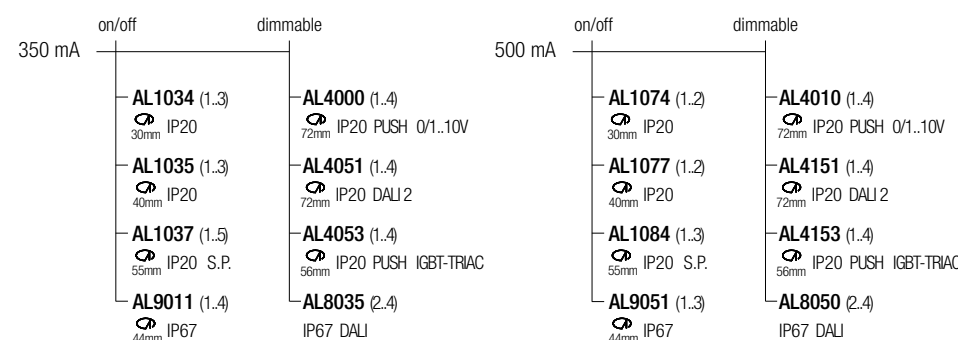

### Accessories

Accessori - Accessoires  
Zubehör - Accesorios

### LEF601

Low luminance louver  
Filtro antiabbagliamento  
Filtre basse luminance  
Geringe Leuchtdichte-Filter  
Filtro de baja luminancia



**Note:** the filter and the screen must be ordered together with the lighting fixture - **Nota:** il filtro e lo schermo devono essere ordinati congiuntamente all'apparecchio - **Note:** le filtre et l'écran doivent être commandées en même temps que l'appareil  
**Anmerkung:** müssen der Filter und der Bildschirm zusammen mit Leuchtkörper bestellt werden  
**Nota:** el filtro y la pantalla deben pedirse juntos con la luminaria

**Note:** cable cut to measure on request  
**Nota:** cavo a misura disponibile su richiesta  
**Note:** câble sur mesure disponible sur demande  
**Anmerkung:** kundenspezifisches Kabel auf Anfrage erhältlich  
**Nota:** cable a medida disponible a petición



# ELF 10

design: Roberto Mantovani

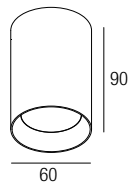

### Supply current

Alimentazione  
Courant d'alimentation  
Stromversorgung  
Corriente de alimentación

500 mA (V<sub>r</sub>, 18V)

### Power

Potenza  
Puissance  
Bestuekung  
Potencia

10 W

### Series wiring

Cablaggio in serie  
Câblage en série  
Verkabelung in Serie  
Cableado en serie



### Photometric diagrams

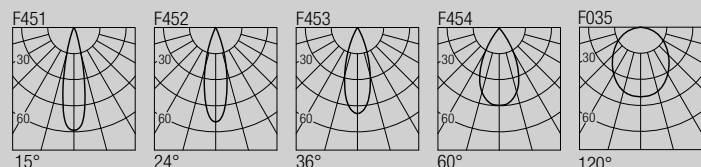

### CCT/CRI/Flux

	CRI85	CRI93
2700K	890lm	840lm
3000K	1000lm	930lm
4000K	1040lm	960lm

### CRI85-93

2-Step MacAdam



### Code Construction

Costruzione del codice - Construction du code produit  
Bau der Produkt-Code - Construcción del código de producto

EF1 X X X X

### Beam angle

	N	S	M	W	X
Apertura di fascio Angle de faisceau Strahlwinkel Ángulo del haz	15°	24°	36°	60°	120°

### CRI

8	9
85	93

### Color Temperature

2	3	4
2700K	3000K	4000K
Temperatura colore Température couleur Temperaturabhängige Farbe Temperatura de color		

### Finishing

1	2	5	9
White Bianco Blanc Weiß Blanco	Grey Grigio Gris	Black Nero Noir Schwarz Negro	COR-TEN
Finitura Finitions Oberflächenfinish Acabados			

### Accessories

Accessori - Accessoires  
Zubehör - Accesorios

### LEF101

Low luminance louver  
Filtro antiabbagliamento  
Filtre basse luminance  
Geringe Leuchtdichte-Filter  
Filtro de baja luminancia

**Note:** the filter and the screen must be ordered together with the lighting fixture - **Nota:** il filtro e lo schermo devono essere ordinati congiuntamente all'apparecchio - **Note:** le filtre et l'écran doivent être commandées en même temps que l'appareil  
**Anmerkung:** müssen der Filter und der Bildschirm zusammen mit Leuchtkörper bestellt werden  
**Nota:** el filtro y la pantalla deben pedirse juntos con la luminaria

### Drivers

Alimentatori - Alimentateurs  
Netzteile - Alimentadores

500 mA	on/off	dimmable
AL1074 (1)	AL4010 (1.2)	
30mm IP20	72mm IP20 PUSH 0/1..10V	
AL1077 (1)	AL4151 (1.2)	
40mm IP20	72mm IP20 DALI 2	
AL1084 (1.2)	AL4153 (1.2)	
55mm IP20 S.P.	56mm IP20 PUSH IGBT-TRIAC	
AL9051 (1.2)	AL8050 (1.2)	
44mm IP67	IP67 DALI	

**Note:** cable cut to measure on request  
**Nota:** cavo a misura disponibile su richiesta  
**Note:** câble sur mesure disponible sur demande  
**Anmerkung:** kundenspezifisches Kabel auf Anfrage erhältlich  
**Nota:** cable a medida disponible a petición

# ELF 724

design: Roberto Mantovani

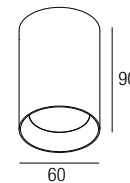

### Supply current

Alimentazione  
Courant d'alimentation  
Stromversorgung  
Corriente de alimentación

500 mA (V<sub>r</sub>, 18V)

### Power

Potenza  
Puissance  
Bestuekung  
Potencia

7 W

### Series wiring

Cablaggio in serie  
Câblage en série  
Verkabelung in Serie  
Cableado en serie



### Photometric diagrams

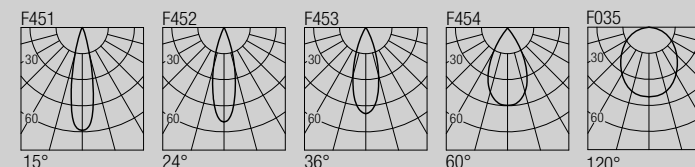

### CCT/CRI/Flux

	CRI85	CRI93
2700K	630lm	590lm
3000K	700lm	650lm
4000K	730lm	670lm

### CRI85-93

2-Step MacAdam



### Code Construction

Costruzione del codice - Construction du code produit  
Bau der Produkt-Code - Construcción del código de producto

EF24 X X X X

### Beam angle

	N	S	M	W	X
Apertura di fascio Angle de faisceau Strahlwinkel Ángulo del haz	15°	24°	36°	60°	120°

### CRI

8	9
85	93

### Color Temperature

2	3	4
2700K	3000K	4000K
Temperatura colore Température couleur Temperaturabhängige Farbe Temperatura de color		

### Finishing

1	2	5	9
White Bianco Blanc Weiß Blanco	Grey Grigio Gris	Black Nero Noir Schwarz Negro	COR-TEN
Finitura Finitions Oberflächenfinish Acabados			

### Accessories

Accessori - Accessoires  
Zubehör - Accesorios

### LEF2401

Low luminance louver  
Filtro antiabbagliamento  
Filtre basse luminance  
Geringe Leuchtdichte-Filter  
Filtro de baja luminancia

**Note:** the filter and the screen must be ordered together with the lighting fixture - **Nota:** il filtro e lo schermo devono essere ordinati congiuntamente all'apparecchio - **Note:** le filtre et l'écran doivent être commandées en même temps que l'appareil  
**Anmerkung:** müssen der Filter und der Bildschirm zusammen mit Leuchtkörper bestellt werden  
**Nota:** el filtro y la pantalla deben pedirse juntos con la luminaria

### Drivers

Alimentatori - Alimentateurs  
Netzteile - Alimentadores

24 VDC	on/off	dimming module	dimmable
AL2012 (1.3)	AL7035	AL5012 (1.3)	
60mm IP20	IP20 PUSH DALI 0/1..10V	45mm IP20 PUSH DALI 0/1..10V	
AL2031 (1.10)		AL8012 (1.3)	
70mm IP20		IP67 DALI	
AL2040 (1.21)			
80mm IP20			
AL9212 (1.2)			
110mm IP67			
AL9231 (1.10)			
85mm IP67			
AL9240 (1.21)			
85mm IP67			

**Note:** cable cut to measure on request  
**Nota:** cavo a misura disponibile su richiesta  
**Note:** câble sur mesure disponible sur demande  
**Anmerkung:** kundenspezifisches Kabel auf Anfrage erhältlich  
**Nota:** cable a medida disponible a petición

**Note:** dimming module AL7035 to be used in combination with an on/off 24VDC power supply **Nota:** modulo di dimmerazione AL7035 da utilizzare in combinazione con un alimentatore on/off 24VDC **Note:** module de variation AL7035 d'intensité à utiliser en combinaison avec une alimentation on/off 24VDC **Anmerkung:** Dimmmodul AL7035 zur Verwendung in Kombination mit einem on/off 24VDC-Netzteil **Nota:** módulo de regulación AL7035 se utiliza en combinación con una fuente de alimentación on/off 24VDC

# FLEXALIGHTING

Flexalighting is part of the group  
Italian Design Brands © 2023

Via Lisbona 21  
50065 Pontassieve  
Firenze, Italy

ph +39.055.83.23.021  
fax +39.055.83.24.866

- ▶ [info@flexalighting.it](mailto:info@flexalighting.it)
- ▶ [www.flexalighting.it](http://www.flexalighting.it)

