

TEAM bollard

Design by
Marco Acerbis

IT Istruzioni di montaggio

EN Assembly instructions

DE Montageanleitung

FR Instructions de montage

ES Instrucciones de montaje



Platek®

TECHNICAL DATA

TEAM bollard - IP65, IK 10

	IT	Classe	Alimentazione	Peso	
	EN	Class	Power supply	Weight	
	DE	Schutzklasse	Versorgung	Gewicht	
	FR	Classe	Alimentation	Poids	
	ES	Clase	Alimentación	Peso	
16W			220-240V 50/60 Hz	8 Kg	TEAM bollard - 600
32W			220-240V 50/60 Hz	9 Kg	TEAM bollard - 900

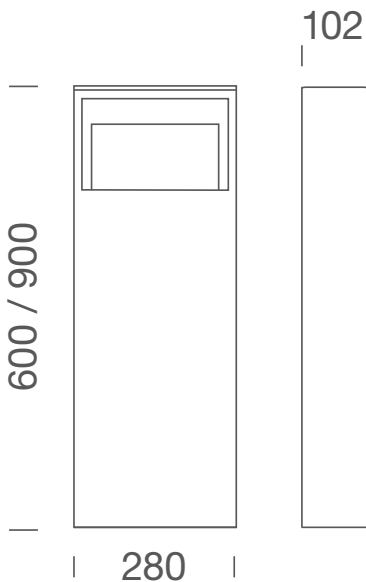
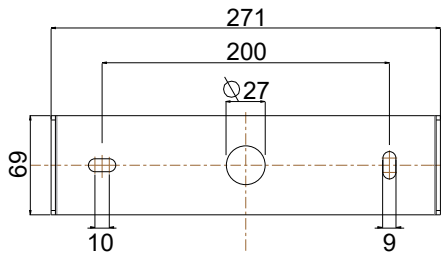

INSTALLATION

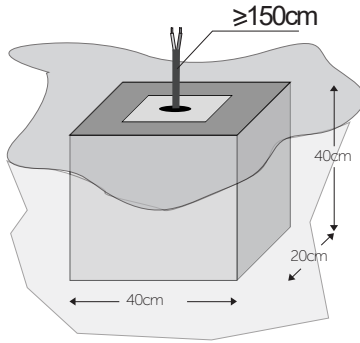

OK!

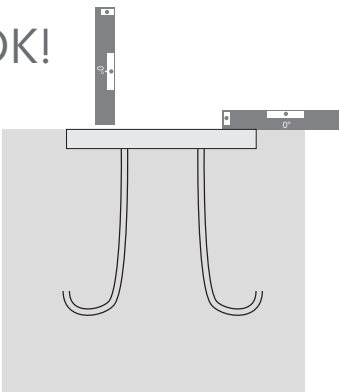

OK!

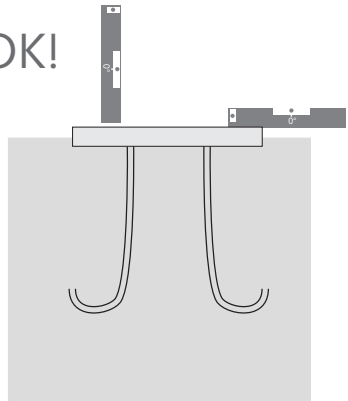

NO!

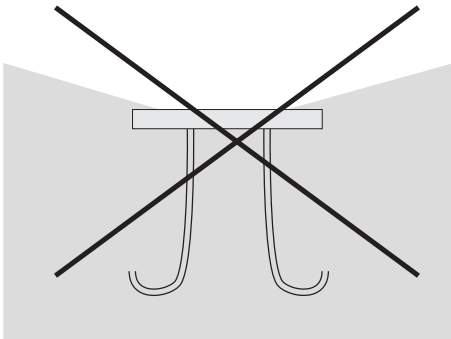

NO!

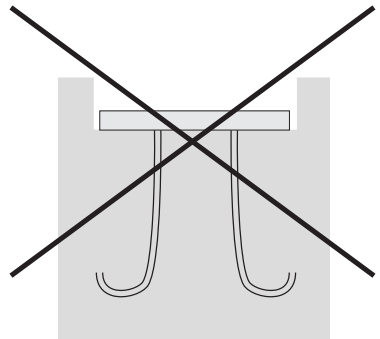

INSTALLATION

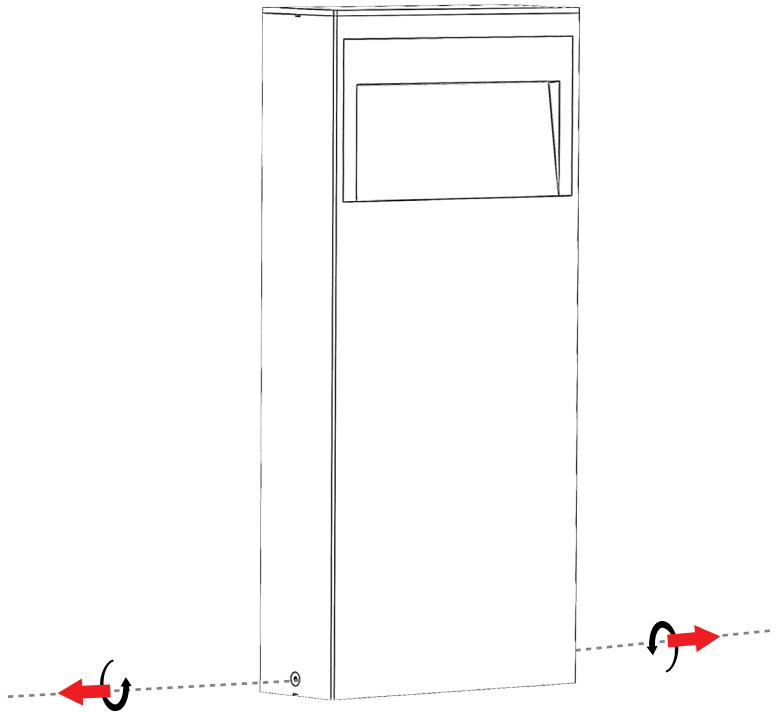
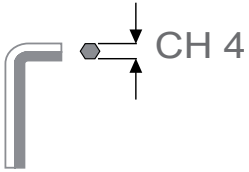

INSTALLATION

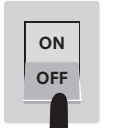

ON



OFF

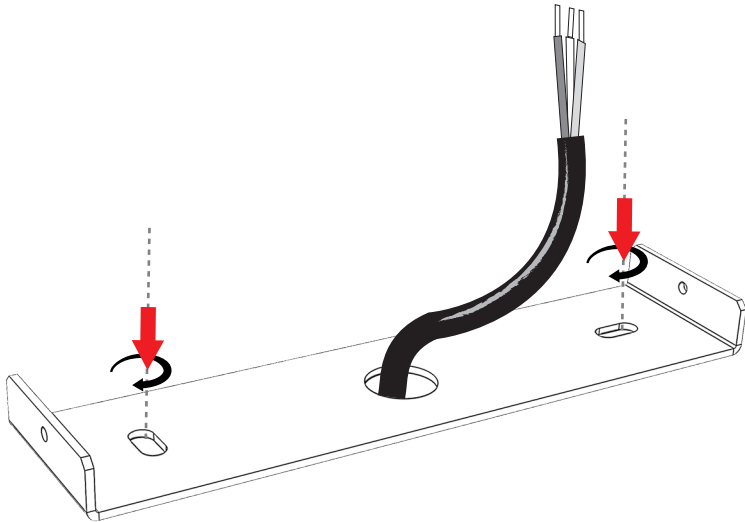

INSTALLATION

- IT** Connettore fornito
- EN** Connector supplied
- DE** Kabelverbinder inklusive
- FR** Connecteur fourni
- ES** Conector suministrado

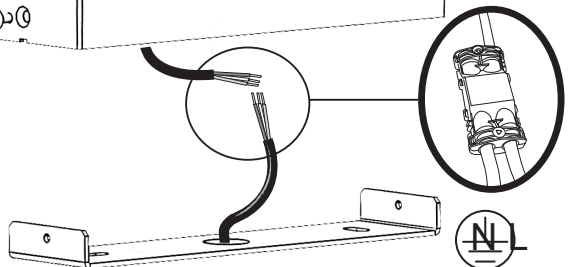
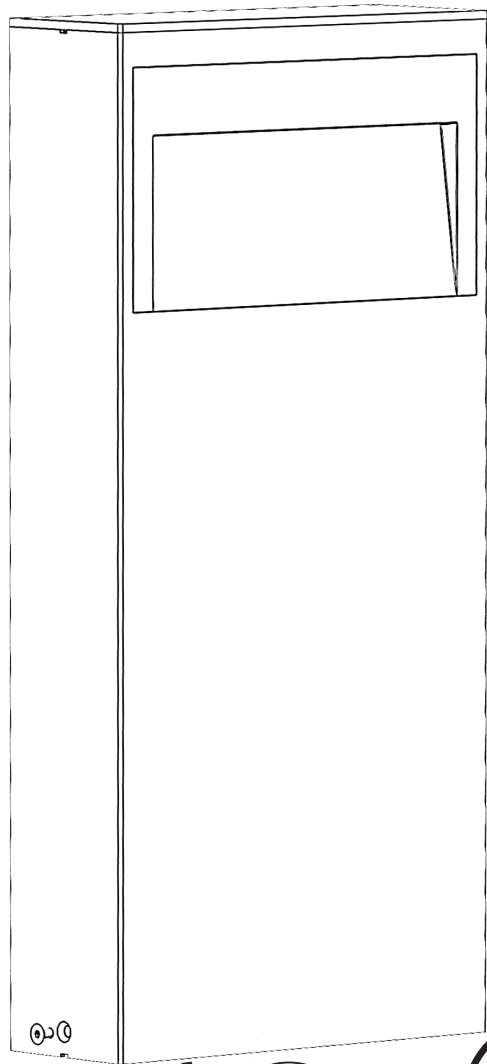
YES**NO**

INSTALLATION

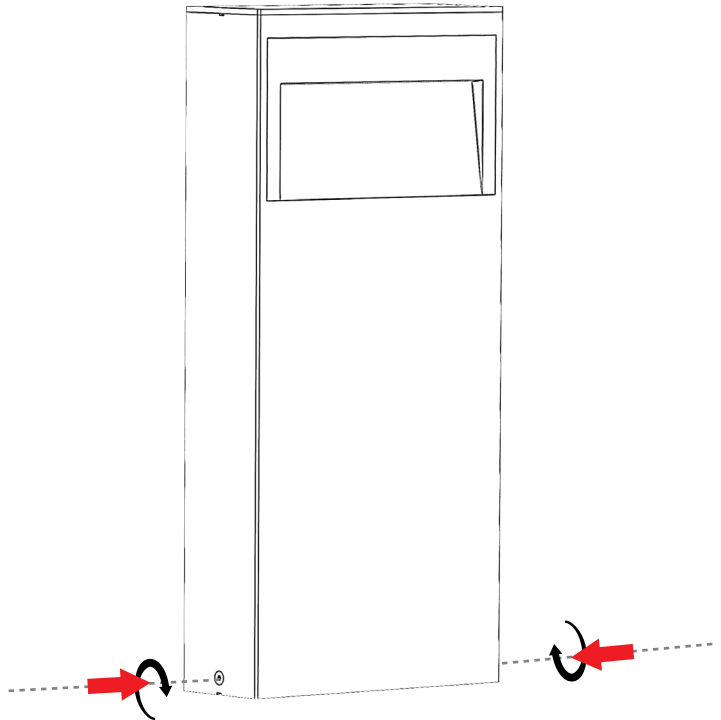
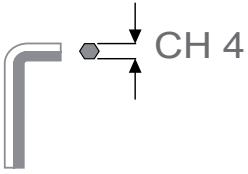

IT COME POSSIAMO ESSERE D'AIUTO?

Ottieni supporto tramite telefono o E-mail, contattandoci al +39 030 68 18 201 o scrivendo all'indirizzo E-mail supporto@platek.eu

EN HOW CAN WE HELP YOU?

Get support by phone or e-mail, call us on +39 030 68 18 201 or send us an email supporto@platek.eu

DE WIE KÖNNEN WIR IHNEN HELFEN?

Sie können unseren Kundendienst per Telefon oder E-Mail erreichen. Kontaktieren Sie uns unter der Telefonnummer +39 030 68 18 201 oder schreiben Sie an folgende E-Mail-Adresse supporto@platek.eu

FR COMMENT POUVONS-NOUS VOUS AIDER?

Vous pouvez obtenir de l'aide par téléphone ou bien par email, en nous contactant +39 030 68 18 201 ou bien en nous écrivant à l'adresse email supporto@platek.eu

ES ¿PODEMOS AYUDARTE?

Solicita soporte a través de nuestro teléfono o email, contactándonos al +39 030 68 18 201 o escribiendo a nuestra dirección de correo electrónico supporto@platek.eu

PLATEK SRL
T + 39 030 6818201
E-MAIL INFO@PLATEK.EU
WWW.PLATEK.EU

REGISTERED OFFICE:
VIA PADERNO 19
25050 RODENGO SAIANO
(BS) ITALY

HEAD OFFICE:
VIA MARROCCO 4
25050 RODENGO SAIANO
(BS) ITALY



IT Conservare le istruzioni.

EN Retain the instructions.

DE Bewahren Sie die Anleitung.

FR Conservez ces instructions.

ES Conserve las instrucciones.